

Aluminio





RIEL DE PERFIL 950 CON CORDÓN

CON TENSOR

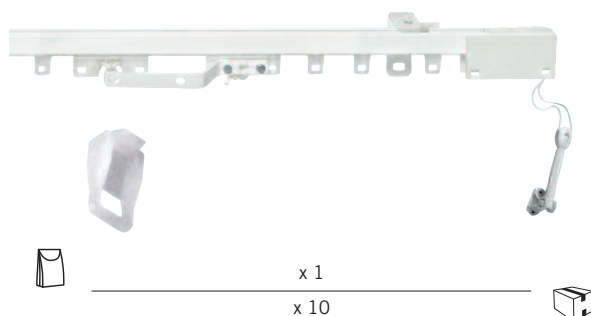

CON CONTRAPESO

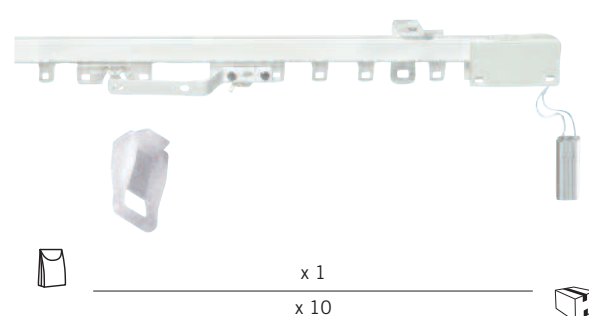

| REF. | <----> | 06 | 40 |
|---------|----------------------|----|----|
| 1958**4 | 1,00 m. (2 soportes) | - | - |
| 0977**4 | 1,50 m. (3 soportes) | - | - |
| 0978**4 | 2,00 m. (3 soportes) | - | - |
| 0954**4 | 2,50 m. (4 soportes) | - | - |
| 0964**4 | 3,00 m. (4 soportes) | - | - |
| 0965**4 | 3,50 m. (4 soportes) | - | - |
| 0981**4 | 4,00 m. (5 soportes) | - | - |

| REF. | <----> | 06 |
|---------|----------------------|----|
| 0838064 | 1,00 m. (2 soportes) | - |
| 0886064 | 1,50 m. (3 soportes) | - |
| 0887064 | 2,00 m. (3 soportes) | - |
| 0888064 | 2,50 m. (4 soportes) | - |
| 0889064 | 3,00 m. (4 soportes) | - |
| 0890064 | 3,50 m. (4 soportes) | - |
| 0869064 | 4,00 m. (5 soportes) | - |

RIEL DE PERFIL 950 SIN CORDÓN

CORREDERA PATÍN I072060

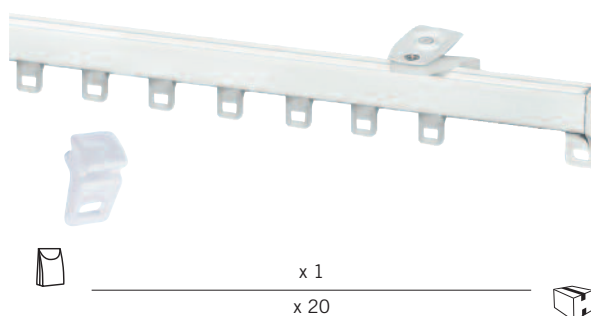

CORREDERA CON RUEDA 0689060

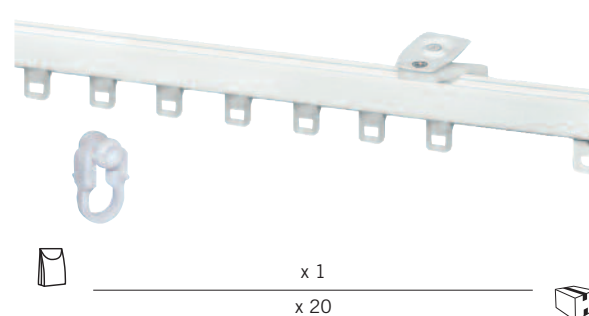

| REF. | <----> | 06 | 40 |
|---------|----------------------|----|----|
| 1959**4 | 1,00 m. (2 soportes) | - | - |
| 0967**4 | 1,50 m. (3 soportes) | - | - |
| 0968**4 | 2,00 m. (3 soportes) | - | - |
| 0969**4 | 2,50 m. (4 soportes) | - | - |
| 0970**4 | 3,00 m. (4 soportes) | - | - |
| 0971**4 | 3,50 m. (4 soportes) | - | - |
| 0997**4 | 4,00 m. (5 soportes) | - | - |

| REF. | <----> | 06 |
|---------|----------------------|----|
| 0739064 | 1,00 m. (2 soportes) | - |
| 0871064 | 1,50 m. (3 soportes) | - |
| 0872064 | 2,00 m. (3 soportes) | - |
| 0873064 | 2,50 m. (4 soportes) | - |
| 0874064 | 3,00 m. (4 soportes) | - |
| 0875064 | 3,50 m. (4 soportes) | - |
| 0797064 | 4,00 m. (5 soportes) | - |

PERFIL 950

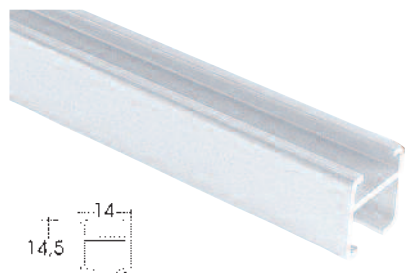

| REF. | <----> | 06 | 07 | 40 |
|---------|--------|----|----|----|
| 0950**0 | 6 m. | - | - | - |
| 1096**0 | 4 m. | - | - | - |
| 1095**0 | 3 m. | - | - | - |
| 1094**0 | 2 m. | - | - | - |

** Colores: 06= Blanco. 07= Negro. 40= Plata.
Código de envasado: 0= Granel. 4= Bolsa de protección.



ACCESORIOS PERFIL 950

CORREDERA FRENTE
(Ristra 10 Unidades)

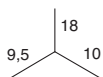

CORREDERA CON RUEDA
(Ristra 10 Unidades)

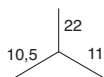
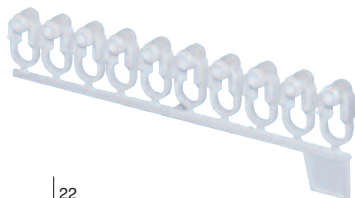

CORREDERA CON HILO "CHYC"
PASO 80

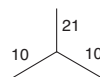

| REF. | 1072**0 | 1072062 | 0689060 | 0232060 |
|------|---------|---------|---------|---------|
|------|---------|---------|---------|---------|

x 400

x 25

x 400

Rollo x 100 m.

| | | | | |
|----|---|---|---|---|
| 06 | - | - | - | - |
| 07 | - | - | - | - |

CORREDERA CON HILO "CHYC"
PASO 60



NOVEDAD

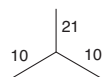

CORREDERA SIMPLE

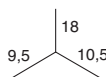

CORREDERA SIMPLE CON RUEDA

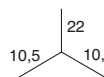

| REF. | 0270060 | 0906060 | 0907060 | 0907062 |
|------|---------|---------|---------|---------|
|------|---------|---------|---------|---------|

Rollo x 100 m.

x 500

x 500

x 20

| | | | | |
|----|---|---|---|---|
| 06 | - | - | - | - |
|----|---|---|---|---|

CORREDERA MAESTRA

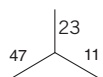
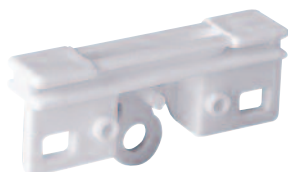

CORREDERA MAESTRA CON RUEDAS

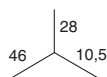
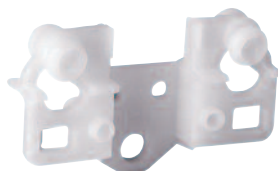

| REF. | 0962060 | 0953060 |
|------|---------|---------|
|------|---------|---------|

x 50

x 50

| | | |
|----|---|---|
| 06 | - | - |
|----|---|---|

Colores: **06**= Blanco. **07**= Negro.
Código de envasado: **0**= Granel. **2**= Blister.

ACCESORIOS PERFIL 950

PUENTE PARA CORREDERA MAESTRA
(recomendado para corredera con hilo)

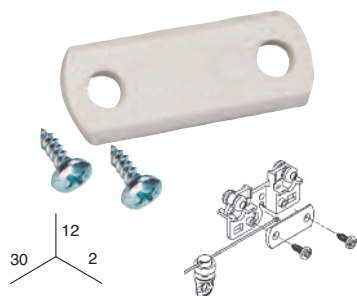

REF. **0652060**

x 50

CORREDERA MAESTRA CON PATA

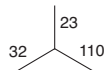

REF. **0913**0**

x 50

CORREDERA MAESTRA CON PATA CORTA
(recomendada para riel con curva)

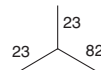

REF. **0856060**

x 50



06
40

-
-

-
-

-
-

CORREDERA MAESTRA CON RUEDA Y PATA

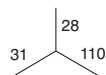

REF. **0952**0**

x 50

CORREDERA MAESTRA CON RUEDA Y PATA CORTA (recomendada para riel con curva)

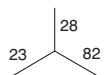

REF. **0851060**

x 50

POLEA INTERMEDIA

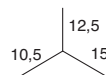

REF. **1230400**

x 50

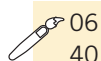

06
40

-
-

-
-

-
-

MANGUITO PORTA-POLEAS

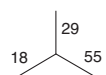
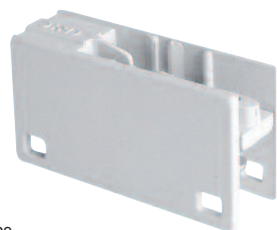

REF. **0957**0**

x 50

TOPE FINAL

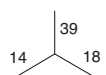

REF. **0905**0**

x 50

UNIÓN ESQUINA

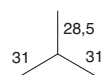

REF. **1073060**

x 25

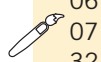

06
07
32

-
-
-

-
-
-

-
-
-

** Colores: 06= Blanco. 07= Negro. 32= Gris. 40= Plata.
Código de envasado: 0= Granel.



ACCESORIOS PERFIL 950

FIJADOR INTERMEDIO

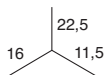

CODO CON 2 EMPALMES
(radio interior=125 mm.)

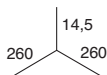

EMPALME
(perfil 950,910 y 900)



| | | | |
|------|----------------|----------------|----------------|
| REF. | 0892060 | 0852**0 | 0956060 |
|------|----------------|----------------|----------------|

x 50

x 10

x 50

| | | | |
|----|---|---|---|
| 06 | - | - | - |
| 40 | - | - | - |

EMPALME
(perfil 950/910)

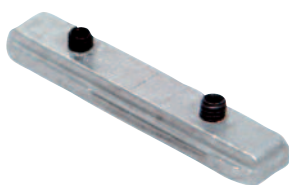

CORDÓN POLIÉSTER Ø2,5



CONTRAPESO CON GANCHO



| | | | | |
|------|----------------|----------------|----------------|----------------|
| REF. | 3950400 | 2556060 | 0400060 | 0400062 |
|------|----------------|----------------|----------------|----------------|

x 10

Carrete x 200 m.

x 25

x 2

| | | | | |
|----|---|---|---|---|
| 06 | - | - | - | - |
| 40 | - | - | - | - |

CONTRAPESO 30 gr.



CONTRAPESO 50 gr.

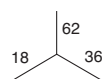

CONTRAPESO 70/110 gr.

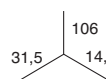

70 gr.

110 gr.

| | | | | | |
|------|----------------|----------------|----------------|----------------|----------------|
| REF. | 0421060 | 0421062 | 1237060 | 1204**0 | 1224060 |
|------|----------------|----------------|----------------|----------------|----------------|

x 50

x 2

x 25

x 10

x 10

| | | | | | |
|----|---|---|---|---|---|
| 06 | - | - | - | - | - |
| 32 | - | - | - | - | - |

Colores: **06**= Blanco. **32**= Gris. **40**= Plata.
Código de envasado: **0**= Granel. **2**= Blister.

ACCESORIOS PERFIL 950

TENSOR

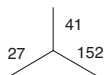
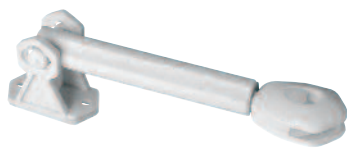

SOPORTE TECHO CON ESTRIBO

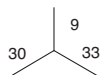

ESTRIBO TECHO (con tornillo y taco)

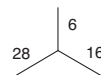

| REF. | 0419060 | 0419062 | 0993**0 | 0993**2 | 0904**0 |
|------|---------|---------|---------|---------|---------|
| | x 25 | x 1 | x 50 | x 2 | x 50 |
| 06 | - | - | - | - | 06 |
| 40 | - | - | - | - | 07 |

SOPORTE 3 cm.

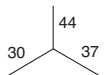

SOPORTE 6 cm.

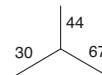

SOPORTE DOBLE 3-9 cm.

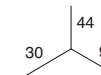

| REF. | 0901**0 | 0902**0 | 0903**0 |
|------|---------|---------|---------|
| | x 50 | x 50 | x 50 |
| 06 | - | - | - |
| 40 | - | - | - |

SOPORTE REFORZADO 3 cm.

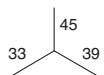

SOPORTE REFORZADO 6 cm.

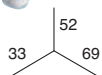

SOPORTE DOBLE REFORZADO 3-9 cm.

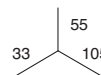

| REF. | 0818**0 | 0818**2 | 0819**0 | 0819**2 | 0960**0 | 0960**2 |
|------|---------|---------|---------|---------|---------|---------|
| | x 50 | x 2 | x 50 | x 2 | x 50 | x 2 |
| 06 | - | - | - | - | - | - |
| 40 | - | - | - | - | - | - |

** Colores: 06= Blanco. 07= Negro. 40= Plata.
Código de envasado: 0= Granel. 2= Blister.



RIEL DE PERFIL 910 CON CORDÓN

CON TENSOR

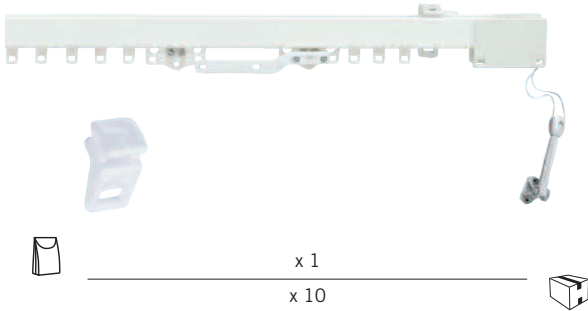

CON CONTRAPESO

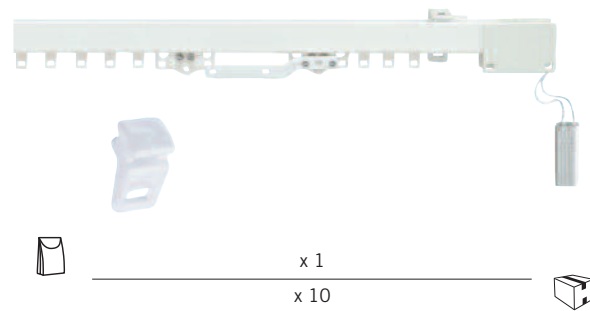

| REF. | <----> | | 06 | 40 |
|---------|----------------------|---|----|----|
| 1960**4 | 1,00 m. (2 soportes) | - | - | - |
| 0972**4 | 1,50 m. (3 soportes) | - | - | - |
| 0973**4 | 2,00 m. (3 soportes) | - | - | - |
| 0974**4 | 2,50 m. (4 soportes) | - | - | - |
| 0975**4 | 3,00 m. (4 soportes) | - | - | - |
| 0976**4 | 3,50 m. (4 soportes) | - | - | - |
| 0979**4 | 4,00 m. (5 soportes) | - | - | - |

| REF. | <----> | | 06 |
|---------|----------------------|---|----|
| 0877064 | 1,00 m. (2 soportes) | - | - |
| 0880064 | 1,50 m. (3 soportes) | - | - |
| 0881064 | 2,00 m. (3 soportes) | - | - |
| 0882064 | 2,50 m. (4 soportes) | - | - |
| 0883064 | 3,00 m. (4 soportes) | - | - |
| 0884064 | 3,50 m. (4 soportes) | - | - |
| 0895064 | 4,00 m. (5 soportes) | - | - |

RIEL DE PERFIL 910 SIN CORDÓN

SOPORTE FRENTE TECHO Y CORREDERA PATÍN I072060

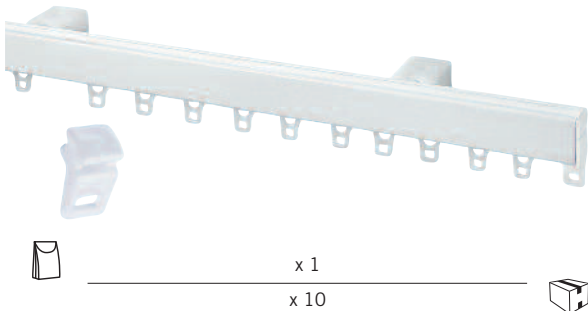

SOPORTE TECHO Y CORREDERA CON RUEDA 0689060

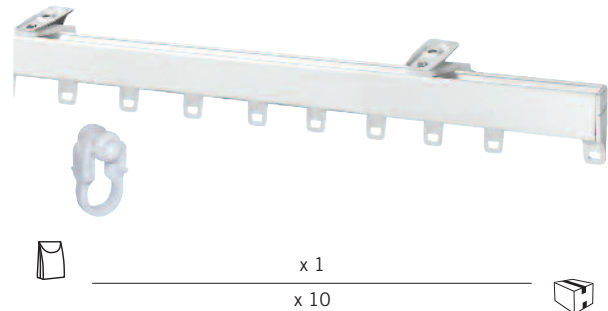

| REF. | <----> | | 06 | 40 |
|---------|----------------------|---|----|----|
| 2225**4 | 1,00 m. (2 soportes) | - | - | - |
| 1926**4 | 1,50 m. (3 soportes) | - | - | - |
| 1927**4 | 2,00 m. (3 soportes) | - | - | - |
| 1928**4 | 2,50 m. (4 soportes) | - | - | - |
| 1929**4 | 3,00 m. (4 soportes) | - | - | - |
| 1930**4 | 3,50 m. (4 soportes) | - | - | - |
| 2226**4 | 4,00 m. (5 soportes) | - | - | - |

| REF. | <----> | | 06 |
|---------|----------------------|---|----|
| 0737064 | 1,00 m. (2 soportes) | - | - |
| 0858064 | 1,50 m. (3 soportes) | - | - |
| 0859064 | 2,00 m. (3 soportes) | - | - |
| 0860064 | 2,50 m. (4 soportes) | - | - |
| 0861064 | 3,00 m. (4 soportes) | - | - |
| 0862064 | 3,50 m. (4 soportes) | - | - |
| 0738064 | 4,00 m. (5 soportes) | - | - |

PERFIL 910

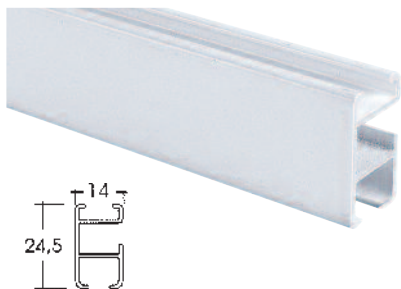

| REF. | <----> | | 06 | | 07 | | 40 |
|---------|--------|---|----|---|----|---|----|
| | x 40 | | | | | | |
| 0910**0 | 6 m. | - | - | - | - | - | - |
| 1093**0 | 4 m. | - | - | - | - | - | - |
| 1092**0 | 3 m. | - | - | - | - | - | - |
| 1091**0 | 2 m. | - | - | - | - | - | - |

Colores: 06= Blanco. 07= Negro. 40= Plata.
Código de envasado: 0= Granel. 4= Bolsa de protección.

ACCESORIOS PERFIL 910

CORREDERA FRENTE
(Ristra 10 Unidades)

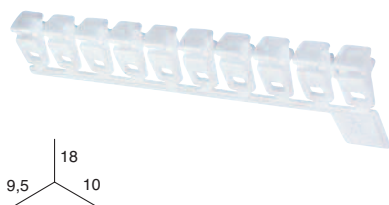

CORREDERA CON RUEDA
(Ristra 10 Unidades)

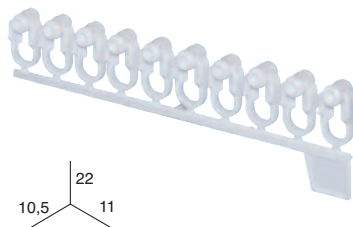

CORREDERA CON HILO "CHYC"



NOVEDAD

| REF. | 1072**0 | 1072062 | 0689060 | 0232060 | 0270060 |
|------|---------|---------|---------|---------|---------|
|------|---------|---------|---------|---------|---------|

x 400

x 25

x 400

PASO 80

PASO 60

Rollo x 100 m.

| | | | | | |
|----|---|---|---|---|---|
| 06 | - | - | - | - | - |
| 07 | - | - | - | - | - |

CORREDERA SIMPLE



CORREDERA SIMPLE CON RUEDA

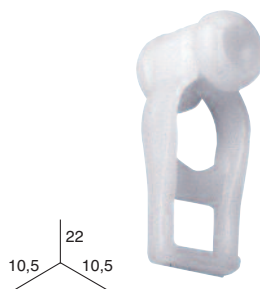

CORREDERA MAESTRA SIN RUEDA

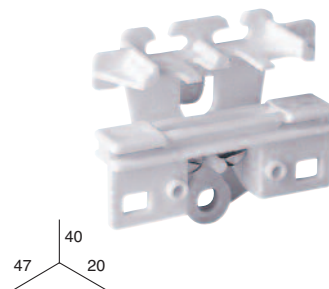

| REF. | 0906060 | 0907060 | 0907062 | 0912060 |
|------|---------|---------|---------|---------|
|------|---------|---------|---------|---------|

x 500

x 500

x 20

x 50

| | | | | |
|----|---|---|---|---|
| 06 | - | - | - | - |
|----|---|---|---|---|

CORREDERA MAESTRA CON RUEDA

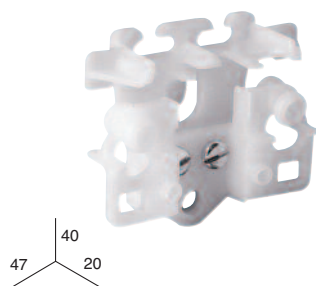

CORREDERA MAESTRA SIN RUEDA
Y CON PATA

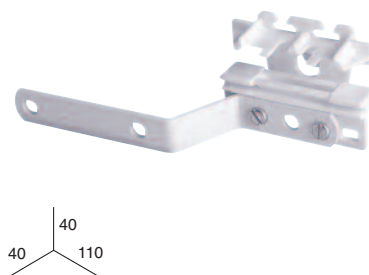

CORREDERA MAESTRA CON RUEDA
Y CON PATA

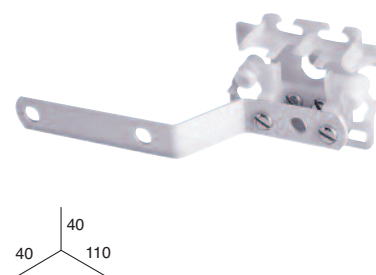

| REF. | 0951060 | 0914**0 | 0911**0 |
|------|---------|---------|---------|
|------|---------|---------|---------|

x 50

x 50

x 50

| | | | |
|----|---|---|---|
| 06 | - | - | - |
| 40 | - | - | - |

** Colores: 06= Blanco. 07= Negro. 40= Plata.
Código de envasado: 0= Granel. 2= Blister.



ACCESORIOS PERFIL 910

PUENTE PARA CORREDERA MAESTRA
(recomendado para corredera con hilo)

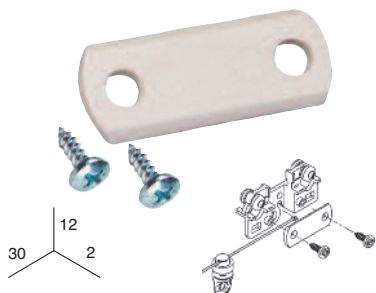

REF. **0652060**

x 50

CORDÓN POLIÉSTER Ø2,5



REF. **2556060**

Carrete x 200 m.

UNIÓN MANGUITOS PORTA-POLEAS P-900 Y 910
(para porta-poleas 7297060 y 7298060)

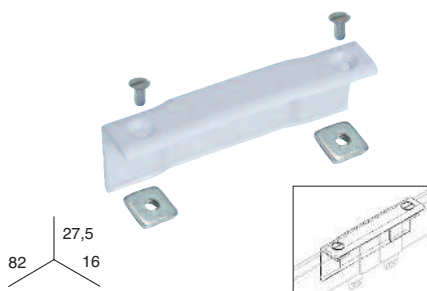

REF. **7430060**

x 10



06

MANGUITO PORTA-POLEAS

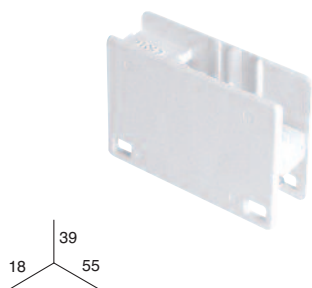

REF. **0958**0**

x 50

PORTA-POLEAS

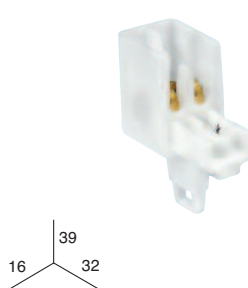

REF. **7298060**

x 50

PORTA-POLEAS RETORNO

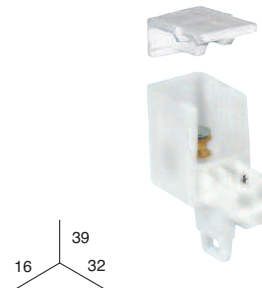

REF. **7397060**

x 50

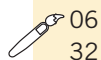

06

32

POLEA INTERMEDIA

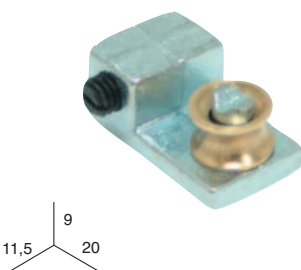

REF. **7297400**

x 50

TOPE FINAL

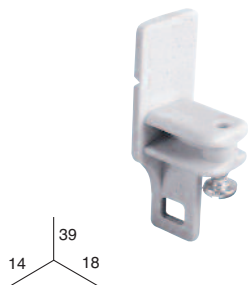

REF. **0905**0**

x 50

FIJADOR INTERMEDIO

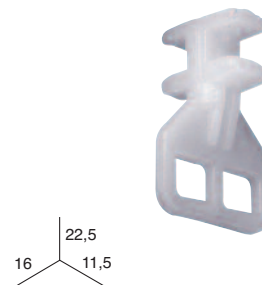

REF. **0892060**

x 50

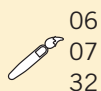

06

07

32

** Colores: **06**= Blanco. **07**= Negro. **32**= Gris. **40**= Plata.
Código de envasado: **0**= Granel.

ACCESORIOS PERFIL 910

EMPALME
(perfil 950,910 y 900)

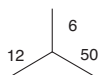

EMPALME
(perfil 950/910)



UNIÓN ESQUINA



TENSOR

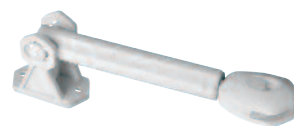

| REF. | 0956060 | 3950400 | 1062060 | 0419060 | 0419062 |
|------|---------|---------|---------|---------|---------|
| | x 50 | x 10 | x 25 | x 25 | x 1 |

| | | | | | |
|--|----|---|---|---|---|
| | 06 | - | - | - | - |
| | 40 | - | - | - | - |

CONTRAPESO 30 gr.

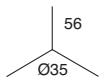

CONTRAPESO 50 gr.
CON GANCHO



CONTRAPESO 50 gr.

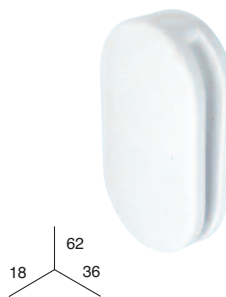

CONTRAPESO 70 gr.



| REF. | 0421060 | 0421062 | 0400060 | 0400062 | 1237060 | 1204**0 |
|------|---------|---------|---------|---------|---------|---------|
| | x 50 | x 2 | x 25 | x 2 | x 25 | x 10 |

| | | | | | | |
|--|----|---|---|---|---|---|
| | 06 | - | - | - | - | - |
| | 32 | - | - | - | - | - |

CONTRAPESO 110 gr.

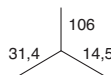

SOPORTE FRENTE

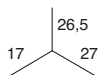
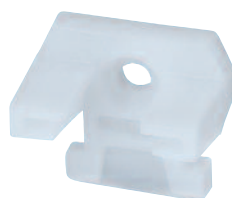

SOPORTE FRENTE-TECHO



SOPORTE LATERAL

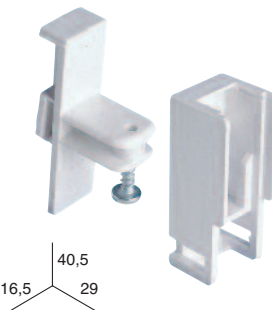

| REF. | 1224060 | 1557060 | 7499060 | 0955**0 |
|------|---------|---------|---------|---------|
| | x 10 | x 50 | x 50 | x 50 |

| | | | | |
|--|----|---|---|---|
| | 06 | - | - | - |
| | 32 | - | - | - |

** Colores: 06= Blanco. 32= Gris. 40= Plata.
Código de envasado: 0= Granel. 2= Blister.



ACCESORIOS PERFIL 910

SOPORTE LATERAL

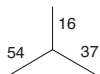

SOPORTE TECHO CON ESTRIBO

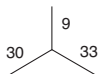

ESTRIBO TECHO
(con tornillo y taco)

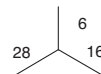

| REF. | 7216**0 | 0993**0 | 0993**2 | 0904**0 |
|------|---------|---------|---------|---------|
| | x 50 | x 50 | x 2 | x 50 |
| 06 | - | - | - | 06 |
| 40 | - | - | - | 07 |

SOPORTE 3 cm.

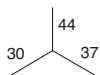

SOPORTE 6 cm.

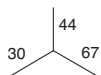

SOPORTE DOBLE 3-9 cm.

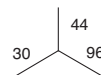

| REF. | 0901**0 | 0902**0 | 0903**0 |
|------|---------|---------|---------|
| | x 50 | x 50 | x 50 |
| 06 | - | - | - |
| 40 | - | - | - |

SOPORTE REFORZADO 3 cm.

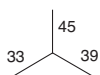

SOPORTE REFORZADO 6 cm.

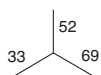

SOPORTE DOBLE REFORZADO 3-9 cm.

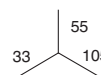

| REF. | 0818**0 | 0818**2 | 0819**0 | 0819**2 | 0960**0 | 0960**2 |
|------|---------|---------|---------|---------|---------|---------|
| | x 50 | x 2 | x 50 | x 2 | x 50 | x 2 |
| 06 | - | - | - | - | - | - |
| 40 | - | - | - | - | - | - |

** Colores: 06= Blanco. 06= Negro. 40= Plata.
Código de envasado: 0= Granel. 2= Blister.



PERFIL 900 Y ACCESORIOS

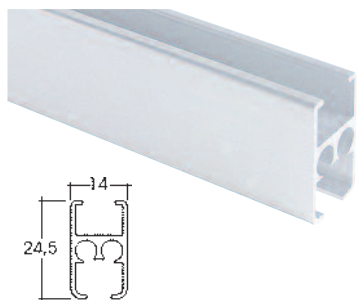

| REF. | ←----→ | 06 | REF. | ←----→ | 40 |
|----------------|--------|----|----------------|--------|----|
| | | | | | |
| 0900060 | 6 m. | - | 0900400 | 6 m. | - |
| 1084060 | 4 m. | - | 1084400 | 4 m. | - |
| 1083060 | 3 m. | - | 1083400 | 3 m. | - |
| 1082060 | 2 m. | - | 1082400 | 2 m. | - |

CORREDERA CON HILO "CHYC"

CORREDERA SIMPLE

CORREDERA SIMPLE CON RUEDA

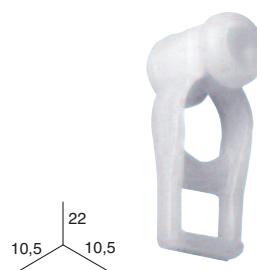
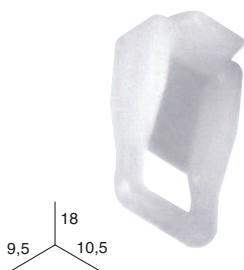
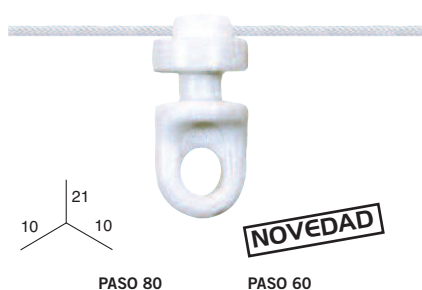

| REF. | 0232060 | 0270060 | 0906060 | 0907060 | 0907062 |
|------|----------------|---------|---------|---------|---------|
| | Rollo x 100 m. | | | | |
| | 06 | - | - | - | - |

CORREDERA CON RUEDA
(Ristra 10 Unidades)

CORREDERA MAESTRA
CON RUEDA Y PATA

CORREDERA MAESTRA CON RUEDA Y PATA
CORTA (recomendada para riel con curva)

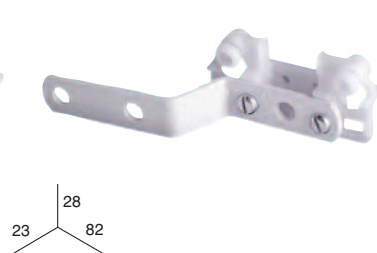
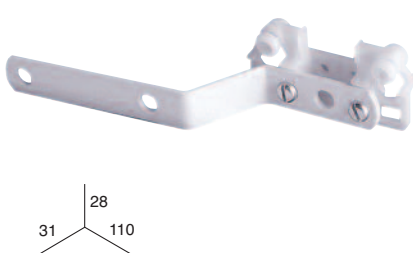
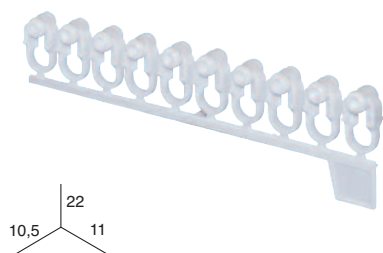

| REF. | 0689060 | 0952**0 | 0851060 |
|------|----------|---------|---------|
| | | | |
| | 06 40 | - - | - - |

** Colores: 06= Blanco. 40= Plata.
Código de envasado: 0= Granel. 2= Blister.



PERFIL 900 Y ACCESORIOS

PUENTE PARA CORREDERA MAESTRA
(recomendado para corredera con hilo)

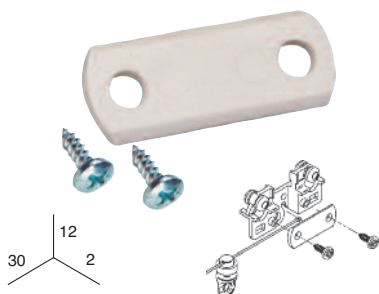

CORREDERA MAESTRA CON RUEDAS

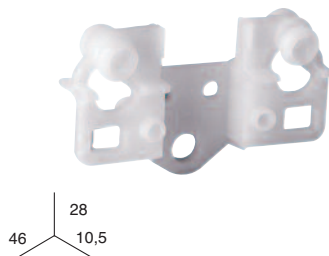

CORREDERA MAESTRA
(Especial para riel curvo)

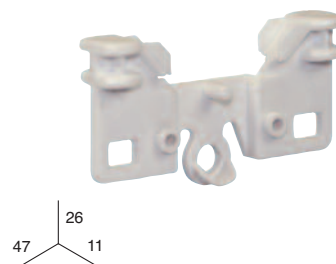

(radio mínimo 125)

| | | | |
|------|----------------|----------------|----------------|
| REF. | 0652060 | 0953060 | 0185060 |
| | x 50 | x 50 | x 25 |

| | | | |
|----|---|---|---|
| 06 | - | - | - |
|----|---|---|---|

CORDÓN POLIÉSTER Ø2,5



UNIÓN MANGUITOS PORTA-POLEAS P-900 Y 910
(para porta-poleas 7297060 y 7298060)

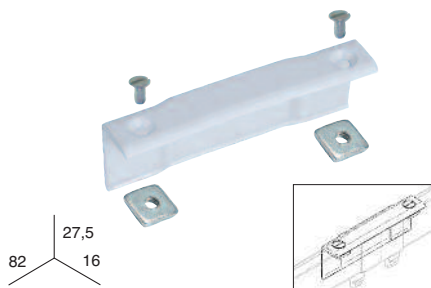

PORTA-POLEAS

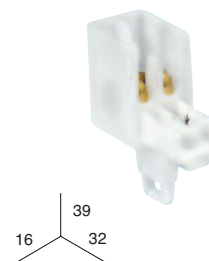

| | | | |
|------|------------------|----------------|----------------|
| REF. | 2556060 | 7430060 | 7298060 |
| | Carrete x 200 m. | x 10 | x 50 |

| | | | |
|----|---|---|---|
| 06 | - | - | - |
|----|---|---|---|

PORTA-POLEAS RETORNO

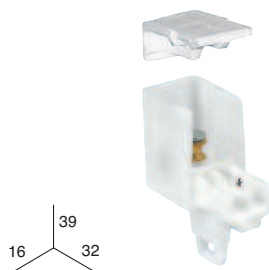

MANGUITO PORTA-POLEAS

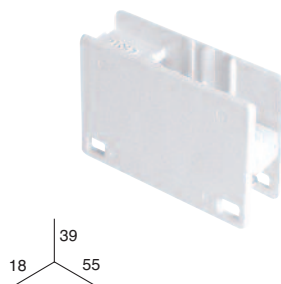

TENSOR

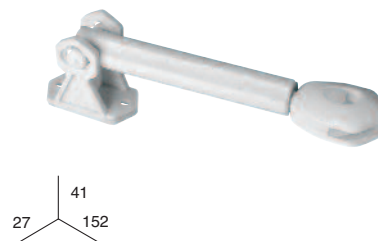

| | | | | |
|------|----------------|---------------|----------------|----------------|
| REF. | 7397060 | 0958*0 | 0419060 | 0419062 |
| | x 50 | x 50 | x 25 | x 1 |

| | | | | |
|----|---|---|---|---|
| 06 | - | - | - | - |
| 32 | - | - | - | - |

** Colores: **06**= Blanco. **32**= Gris.
Código de envasado: **0**= Granel. **2**= Blister.

ACCESORIOS PERFIL 900

EMPALME

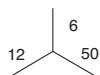

EMPALME

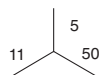
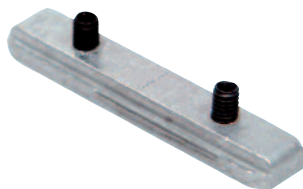

CONTRAPESO 30 gr.

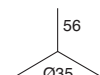

REF. **0956060**

x 50

REF. **3900400**

x 10

REF. **0421060**

x 50

REF. **0421062**

x 50

06
40

| | | | |
|---|---|---|---|
| - | - | - | - |
| - | - | - | - |

CONTRAPESO CON GANCHO



CONTRAPESO 50 gr.



CONTRAPESO 70 gr.

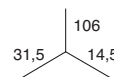

REF. **0400060**

x 25

REF. **0400062**

x 2

REF. **1237060**

x 25

REF. **1204**0**

x 10

06
32

| | | | |
|---|---|---|---|
| - | - | - | - |
| - | - | - | - |

CONTRAPESO 110 gr.

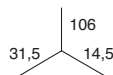

SOPORTE TECHO



ESTRIBO TECHO (Con tornillo y taco)



REF. **1224060**

x 10

REF. **0993**0**

x 50

REF. **0993**2**

x 2

REF. **0904**0**

x 50

06
32

| | | | | |
|---|---|---|----|---|
| - | - | - | 06 | - |
| - | - | - | 07 | - |

** Colores: 06= Blanco. 07= Negro. 32= Gris. 40= Plata.
Código de envasado: 0= Granel. 2= Blister.



ACCESORIOS PERFIL 900

SOPORTE 3 cm.

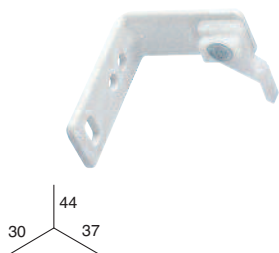

SOPORTE 6 cm.

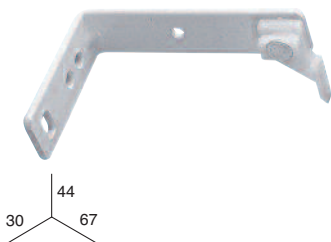

SOPORTE DOBLE 3-9 cm.

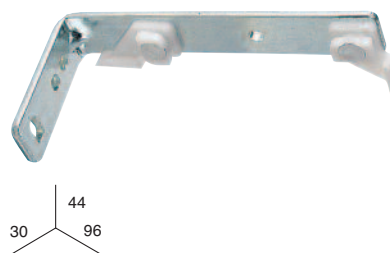

| REF. | 0901**0 | 0902**0 | 0903**0 |
|------|---------|---------|---------|
| | x 50 | x 50 | x 50 |
| 06 | - | - | - |
| 40 | - | - | - |

SOPORTE REFORZADO 3 cm.



SOPORTE REFORZADO 6 cm.

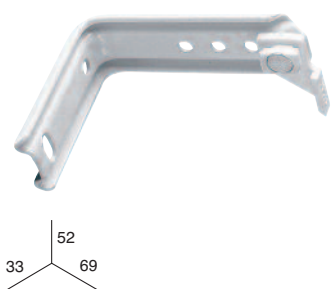

SOPORTE DOBLE REFORZADO 3-9 cm.

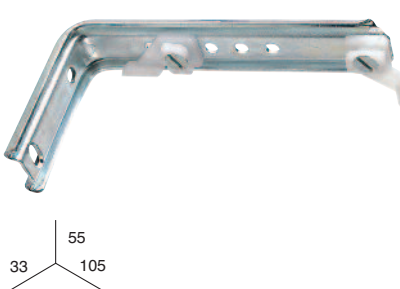

| REF. | 0818**0 | 0818**2 | 0819**0 | 0819**2 | 0960**0 | 0960**2 |
|------|---------|---------|---------|---------|---------|---------|
| | x 50 | x 2 | x 50 | x 2 | x 50 | x 2 |
| 06 | - | - | - | - | - | - |
| 40 | - | - | - | - | - | - |

BRIDA CORDÓN

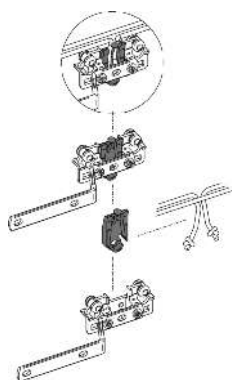

PERFIL RECOMENDADO PARA DOBLE CURVA CON CORDÓN



| REF. | 7801060 |
|------|---------|
| | x 25 |
| 06 | - |

** Colores: 06= Blanco. 40= Plata.
Código de envasado: 0= Granel. 2= Blister.



RIEL DE PERFIL 7247 (para curvar a mano)



x 1

x 10



| REF. | <----> | 06 | REF. | <----> | 06 |
|---------|----------------------|----|---------|----------------------|----|
| 7219062 | 1,50 m. (3 soportes) | - | 7222062 | 3,00 m. (6 soportes) | - |
| 7220062 | 2,00 m. (4 soportes) | - | 7394062 | 3,50 m. (8 soportes) | - |
| 7221062 | 2,50 m. (5 soportes) | - | 7395062 | 4,00 m. (8 soportes) | - |

PERFIL 7247 Y ACCESORIOS (para curvar a mano)

CORREDERA PERFIL I

GRAPA TECHO "CHYC"

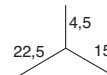
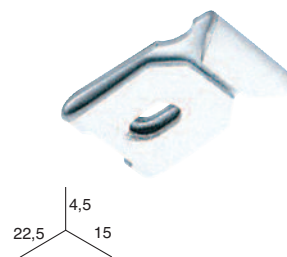
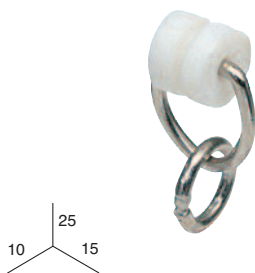
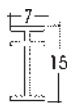
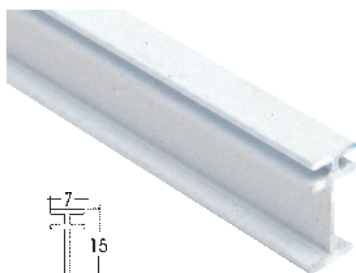

| REF. | <----> | 06 |
|---------|-----------|----|
| 7247060 | 4 m. x 50 | - |
| 7246060 | 3 m. | - |
| 7245060 | 2 m. | - |

| REF. | 7283430 | 7283432 | 7285060 |
|------|---------|---------|---------|
| | x 500 | x 20 | x 100 |
| 43 | - | - | 06 |

ESTRIBO FRENTE
(Para refs. 7187060 y 7188060)

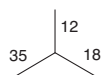
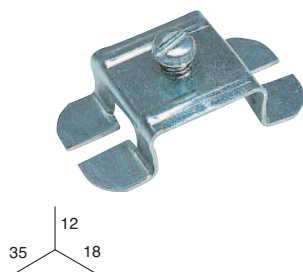

SOPORTE TECHO ARTICULADO

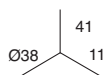

SOPORTE FRENTE-TECHO

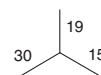

| REF. | 7286400 | 7284400 | 7281060 |
|------|---------|---------|---------|
| | x 100 | x 100 | x 100 |
| 06 | - | - | - |
| 40 | - | - | - |

** Colores: 06= Blanco. 40= Plata. 43= Cromado.
Código de envasado: 0= Granel. 2= Blister.



PERFIL 7247 Y ACCESORIOS

(para curvar a mano)

TOPE FINAL



EMPALME

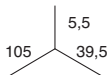

SOPORTE FRENTE 6 cm.
(Para ref. 7286400)

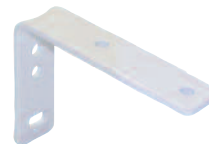

| | | | |
|------|----------------|----------------|----------------|
| REF. | 7278060 | 7800060 | 0771060 |
|------|----------------|----------------|----------------|

x 100

x 50

x 50

06

SOPORTE FRENTE 9 cm.
(Para ref. 7286400)



SOPORTE FRENTE 12 cm.
(Para ref. 7286400)

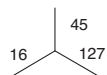

| | | |
|------|----------------|----------------|
| REF. | 7187060 | 7188060 |
|------|----------------|----------------|

x 50

x 50

06

MONTAJE DEL PERFIL 7247 EN GALERÍA

(curvado a mano)

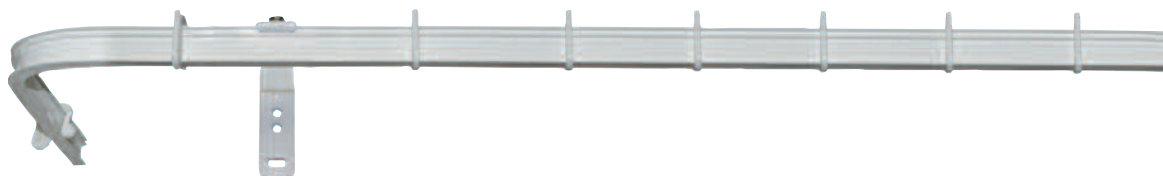

Colores: **06**= Blanco. **40**= Plata.
Código de envasado: **0**= Granel.

PERFIL 908 Y ACCESORIOS

(para división de espacios)

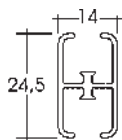
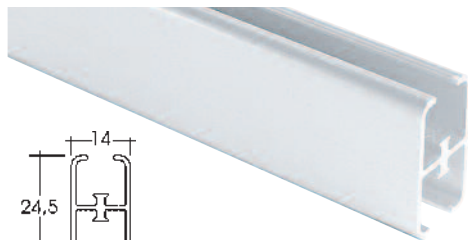

| REF. | <----> | | 06 |
|---------|--------|------|----|
| 0908060 | 6 m. | x 40 | - |
| 1087060 | 4 m. | x 40 | - |
| 1086060 | 3 m. | x 40 | - |
| 1085060 | 2 m. | x 40 | - |

CORREDERA FRENTE
(Ristra 10 Unidades)



| REF. | 1072**0 | 1072062 |
|------|---------|---------|
| | x 400 | x 25 |
| 06 | - | - |
| 07 | - | - |

CORREDERA SIMPLE
(no válida para perfil curvo)

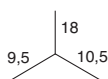

CORREDERA SIMPLE CON RUEDA

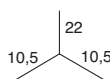

CORREDERA ESPECIAL BAÑO



| REF. | 0906060 | 0907060 | 0907062 | 1201060 |
|------|---------|---------|---------|---------|
| | x 500 | x 500 | x 20 | x 500 |
| 06 | - | - | - | - |

CODO (Radio interior: 93 mm.)

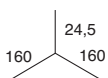
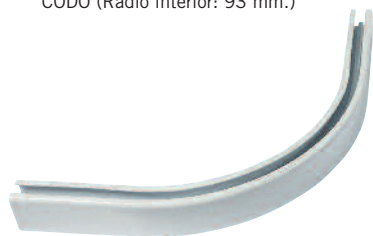

TAPAJUNTAS

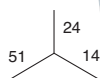

JUNQUILLO DE PLÁSTICO (10 m.)

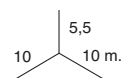

| REF. | 7310060 | 7309060 | 7306060 |
|------|---------|---------|---------|
| | x 12 | x 25 | x 10 |
| 06 | - | - | - |

Colores: 06= Blanco. 07= Negro.
Código de envasado: 0= Granel. 2= Blister.



PERFIL 908 Y ACCESORIOS (para división de espacios)

EMPALME DE ALUMINIO

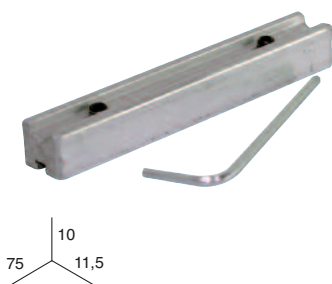

UNIÓN DE PERFILES

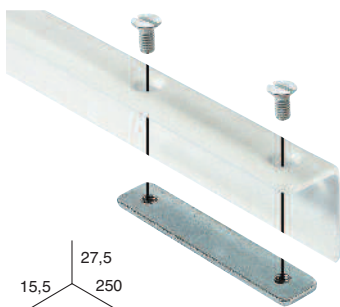

PLETINA UNIÓN CRUZ

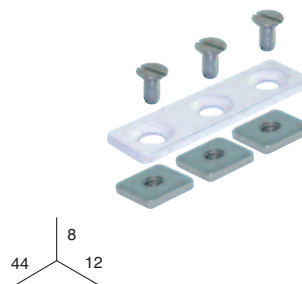

| | | | |
|------|----------------|----------------|----------------|
| REF. | 7320400 | 7305060 | 7307060 |
|------|----------------|----------------|----------------|

| | | | |
|--|------|------|------|
| | x 12 | x 10 | x 25 |
|--|------|------|------|

| | | | |
|----|---|---|---|
| 06 | - | - | - |
| 40 | - | - | - |

ESTRIBO TECHO

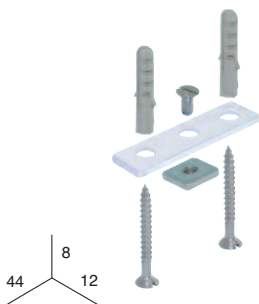

FIJADOR INTERMEDIO

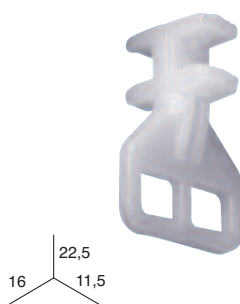

TOPE PORTATELA FIJO

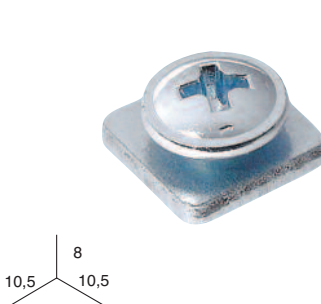

| | | | |
|------|----------------|----------------|----------------|
| REF. | 7308060 | 0892060 | 0917400 |
|------|----------------|----------------|----------------|

| | | | |
|--|------|------|-------|
| | x 25 | x 50 | x 100 |
|--|------|------|-------|

| | | | |
|----|---|---|---|
| 06 | - | - | - |
|----|---|---|---|

TOPE FINAL



SOPORTE LATERAL

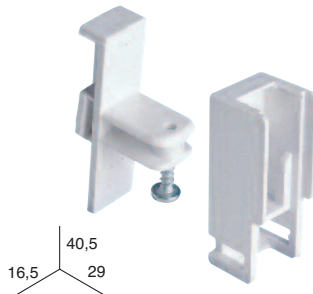

SOPORTE TECHO "CHYC" (0,70 m.)

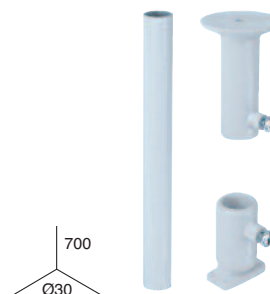

| | | | |
|------|----------------|----------------|----------------|
| REF. | 0905**0 | 0955**0 | 0963**0 |
|------|----------------|----------------|----------------|

| | | | |
|--|------|------|------|
| | x 50 | x 50 | x 25 |
|--|------|------|------|

| | | | |
|----|----|---|---|
| 06 | -. | - | - |
| 07 | -. | - | - |
| 32 | -. | - | - |
| 40 | - | - | - |

** Colores: 06= Blanco. 07= Negro. 32= Gris. 40= Plata.
Código de envasado: 0= Granel.

PERFIL 908 Y ACCESORIOS (para división de espacios)

SOPORTE TECHO "CHYC" (1,00 m.)

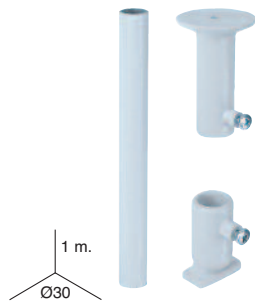

1 m.
Ø30

CASQUILLO RIOSTRA

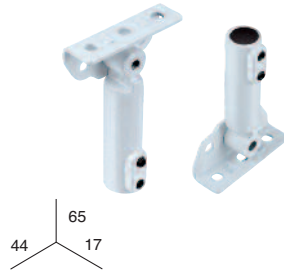

65
44 17

TUBO PARA CASQUILLO RIOSTRA



(3,00 m.)

A medida

| | | | | |
|------|---------|---------|---------|---------|
| REF. | 0654060 | 0744060 | 0437060 | 0437064 |
|------|---------|---------|---------|---------|

x 25

x 6 juegos

x 10



06

MONTAJE CASQUILLO RIOSTRA + TUBO



SENCILLO

DOBLE

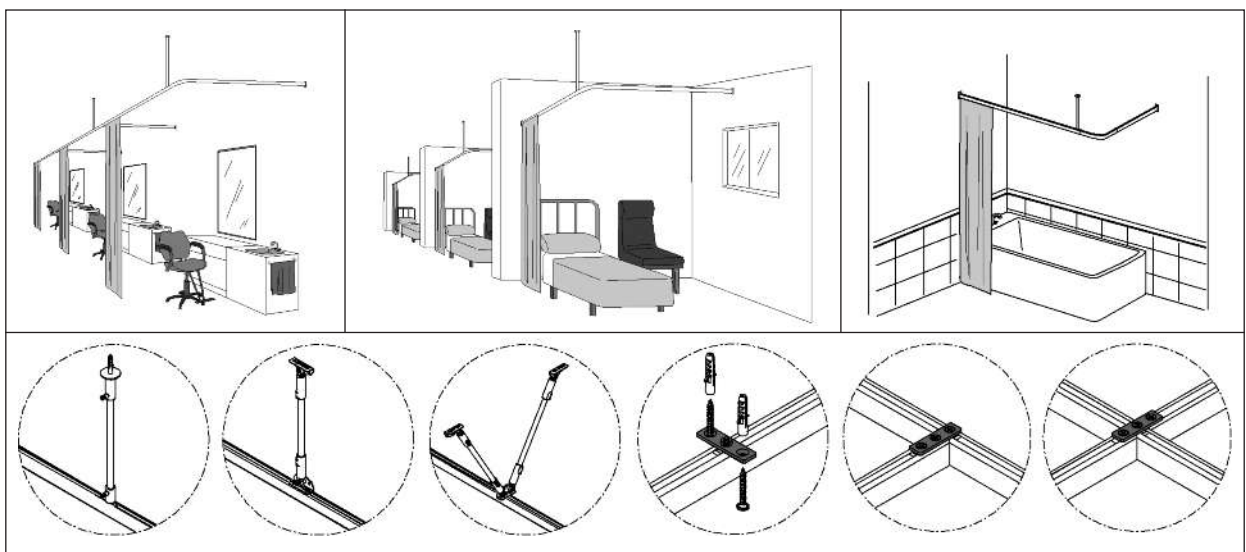

NOTA: Soliciten presupuesto a nuestro departamento comercial.

Colores: **06**= Blanco.
Código de envasado: **0**= Granel. **4**= Bolsa de protección.



RIEL A MEDIDA ONDAS. PERFIL 7600



| ←-----→ | 06. BLANCO | MODALIDAD A | MODALIDAD B | 32. GRIS | MODALIDAD A | MODALIDAD B |
|--------------------------|---------------|---|---|-------------|---|---|
| | | (Distanciador de 9 cm.) A1/ A2/ A3/ A4 | (Distanciador de 6 cm.) B1/ B2/ B3/ B4 | | (Distanciador de 9 cm.) A1/ A2/ A3/ A4 | (Distanciador de 6 cm.) B1/ B2/ B3/ B4 |
| Hasta 0,90 m. (2 sop.) | 9030090 | - | - | 9031090 | - | - |
| De 0,91-1,20 m. (2 sop.) | 9030120 | - | - | 9031120 | - | - |
| De 1,21-1,50 m. (2 sop.) | 9030150 | - | - | 9031150 | - | - |
| De 1,51-1,80 m. (2 sop.) | 9030180 | - | - | 9031180 | - | - |
| De 1,81-2,10 m. (3 sop.) | 9030210 | - | - | 9031210 | - | - |
| De 2,11-2,40 m. (3 sop.) | 9030240 | - | - | 9031240 | - | - |
| De 2,41-2,70 m. (3 sop.) | 9030270 | - | - | 9031270 | - | - |
| De 2,71-3,00 m. (3 sop.) | 9030300 | - | - | 9031300 | - | - |
| De 3,01-3,30 m. (4 sop.) | 9030330 | - | - | 9031330 | - | - |
| De 3,31-3,60 m. (4 sop.) | 9030360 | - | - | 9031360 | - | - |
| De 3,61-3,90 m. (4 sop.) | 9030390 | - | - | 9031390 | - | - |
| De 3,91-4,20 m. (4 sop.) | 9030420 | - | - | 9031420 | - | - |
| De 4,21-4,50 m. (4 sop.) | 9030450 | - | - | 9031450 | - | - |

RIEL A MEDIDA ONDAS DECORATIVO. PERFIL 7600

SOPORTE A TECHO



| ←-----→ | 06. BLANCO | MODALIDAD A | MODALIDAD B | 49. ACERO INOX | MODALIDAD A | MODALIDAD B |
|--------------------------|---------------|---|---|----------------------|---|---|
| | | (Distanciador de 9 cm.) A1/ A2/ A3/ A4 | (Distanciador de 6 cm.) B1/ B2/ B3/ B4 | | (Distanciador de 9 cm.) A1/ A2/ A3/ A4 | (Distanciador de 6 cm.) B1/ B2/ B3/ B4 |
| Hasta 0,90 m. (2 sop.) | 9087090 | - | - | 9058090 | - | - |
| De 0,91-1,20 m. (2 sop.) | 9087120 | - | - | 9058120 | - | - |
| De 1,21-1,50 m. (2 sop.) | 9087150 | - | - | 9058150 | - | - |
| De 1,51-1,80 m. (2 sop.) | 9087180 | - | - | 9058180 | - | - |
| De 1,81-2,10 m. (3 sop.) | 9087210 | - | - | 9058210 | - | - |
| De 2,11-2,40 m. (3 sop.) | 9087240 | - | - | 9058240 | - | - |
| De 2,41-2,70 m. (3 sop.) | 9087270 | - | - | 9058270 | - | - |
| De 2,71-3,00 m. (3 sop.) | 9087300 | - | - | 9058300 | - | - |
| De 3,01-3,30 m. (4 sop.) | 9087330 | - | - | 9058330 | - | - |
| De 3,31-3,60 m. (4 sop.) | 9087360 | - | - | 9058360 | - | - |
| De 3,61-3,90 m. (4 sop.) | 9087390 | - | - | 9058390 | - | - |
| De 3,91-4,20 m. (4 sop.) | 9087420 | - | - | 9058420 | - | - |
| De 4,21-4,50 m. (4 sop.) | 9087450 | - | - | 9058450 | - | - |

SOPORTE FRENTE DECORATIVO



| ←-----→ | 06. BLANCO | MODALIDAD A | MODALIDAD B | 49. ACERO INOX | MODALIDAD A | MODALIDAD B |
|--------------------------|---------------|---|---|----------------------|---|---|
| | | (Distanciador de 9 cm.) A1/ A2/ A3/ A4 | (Distanciador de 6 cm.) B1/ B2/ B3/ B4 | | (Distanciador de 9 cm.) A1/ A2/ A3/ A4 | (Distanciador de 6 cm.) B1/ B2/ B3/ B4 |
| Hasta 0,90 m. (2 sop.) | 9062090 | - | - | 9050090 | - | - |
| De 0,91-1,20 m. (2 sop.) | 9062120 | - | - | 9050120 | - | - |
| De 1,21-1,50 m. (2 sop.) | 9062150 | - | - | 9050150 | - | - |
| De 1,51-1,80 m. (2 sop.) | 9062180 | - | - | 9050180 | - | - |
| De 1,81-2,10 m. (3 sop.) | 9062210 | - | - | 9050210 | - | - |
| De 2,11-2,40 m. (3 sop.) | 9062240 | - | - | 9050240 | - | - |
| De 2,41-2,70 m. (3 sop.) | 9062270 | - | - | 9050270 | - | - |
| De 2,71-3,00 m. (3 sop.) | 9062300 | - | - | 9050300 | - | - |
| De 3,01-3,30 m. (4 sop.) | 9062330 | - | - | 9050330 | - | - |
| De 3,31-3,60 m. (4 sop.) | 9062360 | - | - | 9050360 | - | - |
| De 3,61-3,90 m. (4 sop.) | 9062390 | - | - | 9050390 | - | - |
| De 3,91-4,20 m. (4 sop.) | 9062420 | - | - | 9050420 | - | - |
| De 4,21-4,50 m. (4 sop.) | 9062450 | - | - | 9050450 | - | - |

NOTA: A partir de 3 m. el riel irá montado con el empalme 7604.

NOTA: Los rieles montados sin cordón tienen el mismo precios que los rieles montados con cordón.

COMPONENTES RIEL ONDAS Y RIEL ONDAS DECORATIVO

MODALIDAD A con distanciador de 9 cm. (rf. 0246**0) / MODALIDAD B con distanciador de 6 cm. (rf. 0247**0)

MODALIDAD A1/B1/A3/B3 (apertura lateral o central con cordón): Distanciador correspondiente, perfil 7600, corredera (rf. 0241**0), corredera maestra (rf. 0242**0), unión hilos (rf. 0245**0), soporte techo (rf. 0252**0), portapoleas (rf.0250**0) y cordón (rf. 2551**0).

MODALIDAD A2/B2/A4/B4 (apertura lateral o central sin cordón): Distanciador correspondiente, perfil 7600, corredera (rf. 0241**0), soporte techo (rf. 0252**0) y tapón (rf.7605**0).



TABLA DE LONGITUDES

Montaje de riel con la cinta Cortitex 75/2.



CON CORDÓN. RECOGIDA SIMÉTRICA

| Nº de Ondas | Nº de Enganches | Nº de Correderas | Distanciador 9 cm. | Distanciador 6 cm. |
|-------------|-----------------|------------------|--------------------|--------------------|
| 2 | 8 | 3 | 0,58 | 0,40 |
| 3 | 12 | 5 | 0,94 | 0,64 |
| 4 | 16 | 7 | 1,30 | 0,88 |
| 5 | 20 | 9 | 1,66 | 1,12 |
| 6 | 24 | 11 | 2,01 | 1,35 |
| 7 | 28 | 13 | 2,37 | 1,59 |
| 8 | 32 | 15 | 2,73 | 1,83 |
| 9 | 36 | 17 | 3,09 | 2,07 |
| 10 | 40 | 19 | 3,45 | 2,31 |
| 11 | 44 | 21 | 3,80 | 2,54 |
| 12 | 48 | 23 | 4,16 | 2,78 |
| 13 | 52 | 25 | 4,52 | 3,02 |
| 14 | 56 | 27 | 4,88 | 3,26 |

CON CORDÓN. RECOGIDA A UN LADO

| Nº de Ondas | Nº de Enganches | Nº de Correderas | Distanciador 9 cm. | Distanciador 6 cm. |
|-------------|-----------------|------------------|--------------------|--------------------|
| 3 | 6 | 5 | 0,49 | 0,34 |
| 4 | 8 | 7 | 0,67 | 0,46 |
| 5 | 10 | 9 | 0,85 | 0,58 |
| 6 | 12 | 11 | 1,03 | 0,70 |
| 7 | 14 | 13 | 1,21 | 0,82 |
| 8 | 16 | 15 | 1,39 | 0,94 |
| 9 | 18 | 17 | 1,57 | 1,06 |
| 10 | 20 | 19 | 1,75 | 1,18 |
| 11 | 22 | 21 | 1,92 | 1,29 |
| 12 | 24 | 23 | 2,10 | 1,41 |
| 13 | 26 | 25 | 2,28 | 1,53 |
| 14 | 28 | 27 | 2,46 | 1,65 |
| 15 | 30 | 29 | 2,64 | 1,77 |
| 16 | 32 | 31 | 2,82 | 1,89 |
| 17 | 34 | 33 | 3,00 | 2,01 |
| 18 | 36 | 35 | 3,18 | 2,13 |
| 19 | 38 | 37 | 3,36 | 2,25 |
| 20 | 40 | 39 | 3,54 | 2,37 |
| 21 | 42 | 41 | 3,71 | 2,48 |
| 22 | 44 | 43 | 3,89 | 2,60 |
| 23 | 46 | 45 | 4,07 | 2,72 |
| 24 | 48 | 47 | 4,25 | 2,84 |
| 25 | 50 | 49 | 4,43 | 2,96 |
| 26 | 52 | 51 | 4,61 | 3,08 |
| 27 | 54 | 53 | 4,79 | 3,20 |
| 28 | 56 | 55 | 4,97 | 3,32 |

RIEL SIN CORDÓN. PERFIL 7600

CORREDERA REF. 06B9060

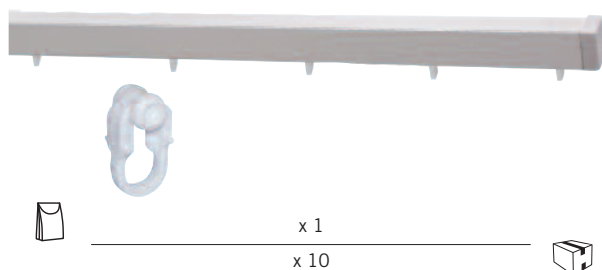

| REF. | <----> | 06 | 32 |
|---------|----------------------|----|----|
| 7479**4 | 1,50 m. (3 soportes) | - | - |
| 7480**4 | 2,00 m. (3 soportes) | - | - |
| 7481**4 | 2,50 m. (4 soportes) | - | - |
| 7482**4 | 3,00 m. (4 soportes) | - | - |
| 7483**4 | 3,50 m. (4 soportes) | - | - |
| 7484**4 | 4,00 m. (5 soportes) | - | - |

CORREDERA REF. 8075060

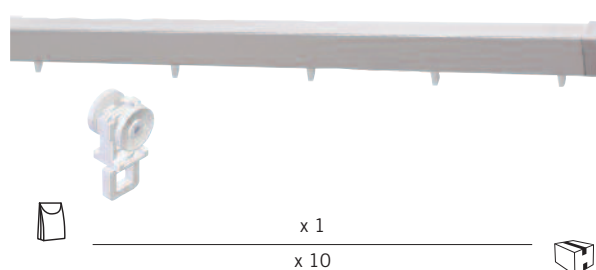

| REF. | <----> | 06 | 32 |
|---------|----------------------|----|----|
| 7485**4 | 1,50 m. (3 soportes) | - | - |
| 7486**4 | 2,00 m. (3 soportes) | - | - |
| 7487**4 | 2,50 m. (4 soportes) | - | - |
| 7488**4 | 3,00 m. (4 soportes) | - | - |
| 7489**4 | 3,50 m. (4 soportes) | - | - |
| 7490**4 | 4,00 m. (5 soportes) | - | - |

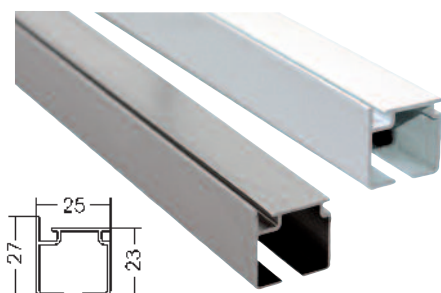

PERFIL 7600

| REF. | <----> | 06 | 32 | 49 |
|---------|--------|----|----|----|
| 7600**0 | 6 m. | - | - | - |
| 7603**0 | 4 m. | - | - | - |
| 7606490 | 3 m. | - | - | - |

** Colores: 06= Blanco. 32= Gris. 49= Acero inoxidable.
Código de envasado: 0= Granel. 4= Bolsa de protección.



ACCESORIOS

CORREDERA SIMPLE
(Siempre junto al distanciador)

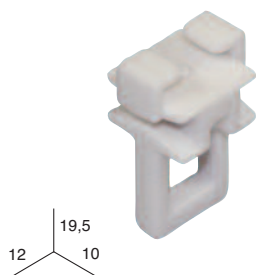

CORREDERA MAESTRA UNION DE HILOS (Interior)

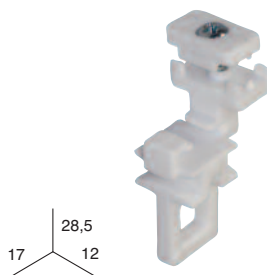

CORREDERA MAESTRA UNION DE HILOS (Exterior)

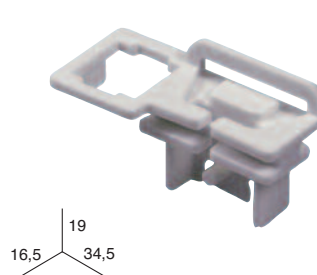

| REF. | 0241**0 | 0242060 | 0245**0 |
|------|---------|---------|---------|
|------|---------|---------|---------|

x 200

x 50

x 50

| | | | |
|----|---|---|---|
| 06 | - | - | - |
| 32 | - | - | - |

DISTANCIADOR 9 cm.

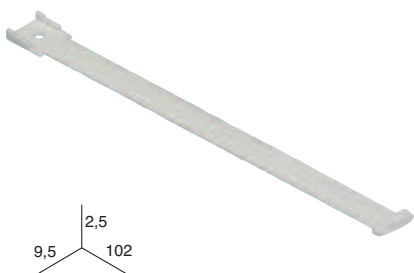

DISTANCIADOR 6 cm.

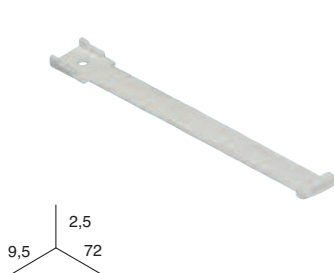

2 PORTAPOLEAS Y 1 BRIDA (juego)

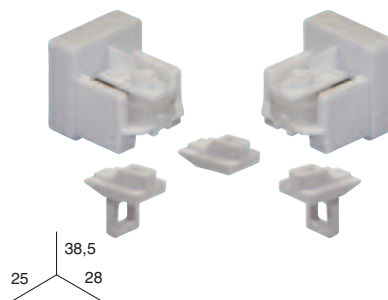

| REF. | 0246**0 | 0247**0 | 0250**0 |
|------|---------|---------|---------|
|------|---------|---------|---------|

x 250

x 250

x 25 juegos

| | | | |
|----|---|---|---|
| 06 | - | - | - |
| 32 | - | - | - |

SOPORTE TECHO

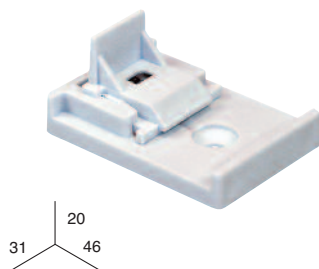

EMPALME

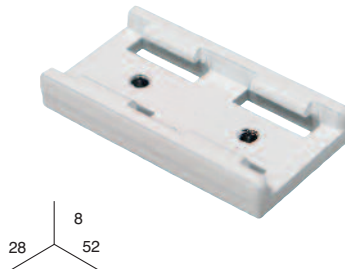

CORDÓN TRENZADO Ø2



| REF. | 0252**0 | 7604**0 | 2551**0 |
|------|---------|---------|---------|
|------|---------|---------|---------|

x 25

x 10

Carrete x 200 m.

| | | | |
|----|---|---|---|
| 06 | - | - | - |
| 32 | - | - | - |

** Colores: **06**= Blanco. **32**= Gris.
Código de envasado: **0**= Granel.



ACCESORIOS

CINTA CORTITEX 75/2. TRANSPARENTE

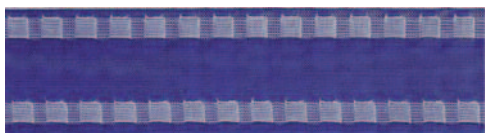

| Ganchos nº de bolsa | | RAPPORT | |
|------------------------|-------------|-----------------------|-----------------------|
| | | Distanciador 6 cm. | Distanciador 9 cm. |
| 6 | A= 9,5 cm. | 1,5/1 | - |
| 8 | A= 13 cm. | 2/1 | - |
| 8 | A= 13 cm. | - | 1,5/1 |
| 10 | A= 15,5 cm. | - | 2/1 |

| REF. | 0256201 | 0256204 |
|------|----------------|---------|
| | Rollo x 100 m. | Metraje |
| 20 | - | - |

SOPORTE DECORATIVO

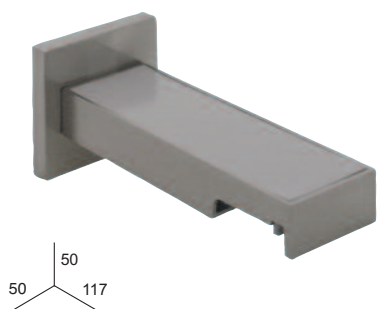

REF. 7607**4



x 1

06
49

PROLONGADOR PARA SOPORTE DECORATIVO

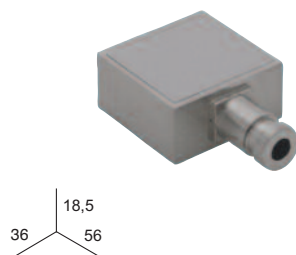

REF. 7608**4



x 1

-
-

TAPÓN PARA RIEL ONDAS DECORATIVO

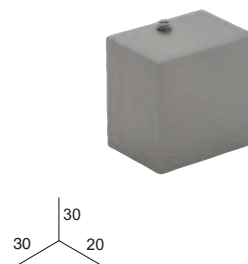

REF. 7609**4



x 1

-
-

CORREDERA CON RUEDA
(Ristra 10 Unidades)

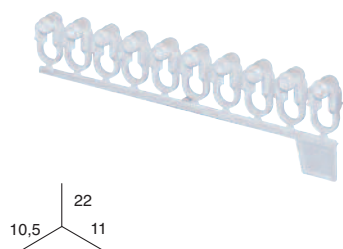

REF. 0689060

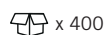

x 400

06
32

CORREDERA CON EJE ROTATIVO

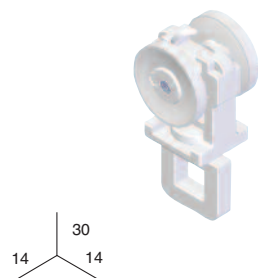

REF. 8075060

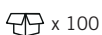

x 100

-
-

TAPÓN PERFIL

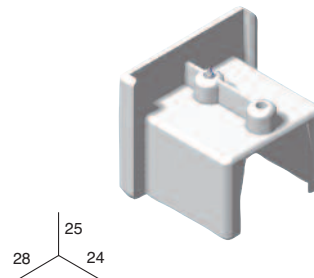

REF. 7605**0

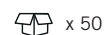

x 50

-
-

** Colores: 06= Blanco. 20= Transparente. 32= Gris. 49= Acero inoxidable.
Código de envasado: 0= Granel. 1= Caja. 4= Bolsa de protección.



RIEL A MEDIDA PROFESIONAL PERFIL 7700



| ←----→ | Referencia | Modalidad A | Modalidad B | Modalidad C | Modalidad D |
|----------------|------------|-------------|-------------|-------------|-------------|
| Hasta 1,00 m. | 9085100 | - | - | - | - |
| De 1,01 - 1,25 | 9085125 | - | - | - | - |
| De 1,26 - 1,50 | 9085150 | - | - | - | - |
| De 1,51 - 1,75 | 9085175 | - | - | - | - |
| De 1,75 - 2,00 | 9085200 | - | - | - | - |
| De 2,01 - 2,25 | 9085225 | - | - | - | - |
| De 2,26 - 2,50 | 9085250 | - | - | - | - |
| De 2,51 - 2,75 | 9085275 | - | - | - | - |
| De 2,76 - 3,00 | 9085300 | - | - | - | - |
| De 3,01 - 3,25 | 9085325 | - | - | - | - |
| De 3,26 - 3,50 | 9085350 | - | - | - | - |
| De 3,51 - 3,75 | 9085375 | - | - | - | - |
| De 3,76 - 4,00 | 9085400 | - | - | - | - |
| De 4,01 - 4,25 | 9085425 | - | - | - | - |
| De 4,26 - 4,50 | 9085450 | - | - | - | - |
| De 4,51 - 4,75 | 9085475 | - | - | - | - |
| De 4,76 - 5,00 | 9085500 | - | - | - | - |
| De 5,01 - 5,25 | 9085525 | - | - | - | - |
| De 5,26 - 5,50 | 9085550 | - | - | - | - |
| De 5,51 - 5,75 | 9085575 | - | - | - | - |
| De 5,76 - 6,00 | 9085600 | - | - | - | - |

COMPONENTES

MODALIDAD A: Perfil, corredera simple (10/metro), tapones y soportes a techo (2 por metro).

MODALIDAD B: Modalidad A mas una corredera maestra.

MODALIDAD C: Modalidad A mas dos corredera maestra.

NOTA ACLARATORIA: El conjunto incorpora la tornillería de fijación de los soportes a techo. Si el cliente quiere el montaje a frente, se deducirán los soportes a techo y se incluirán las escuadras o soportes de pared del modelo y medida que el cliente solicite, así como la tornillería necesaria. Ambos componentes se facturarán aparte

NOVEDAD

ACCESORIOS RIEL PROFESIONAL

PERFIL 7700 DE 6,00 m.

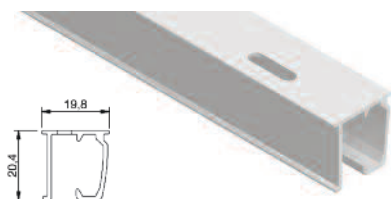

CORREDERA SIMPLE

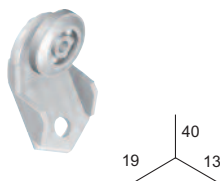

CORREDERA MAESTRA

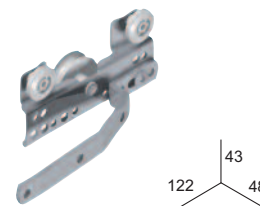

| | | | |
|------|---------|---------|---------|
| REF. | 7700060 | 0275060 | 0276400 |
| | x 20 | x 50 | x 10 |

CORREDERA AUXILIAR

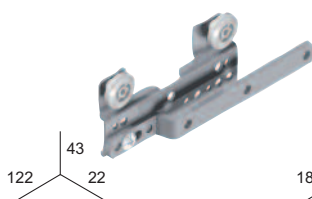

TAPÓN PARA PERFIL

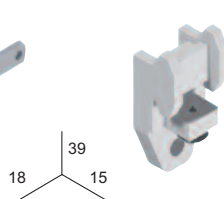

SOPORTE TECHO

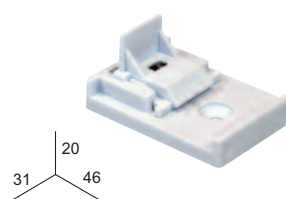

EMPALME

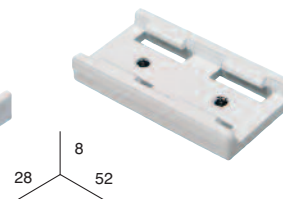

| | | | | |
|------|---------|---------|---------|---------|
| REF. | 0277400 | 0278060 | 0252060 | 7604060 |
| | x 10 | x 50 | x 25 | x 10 |

Colores: 06= Blanco. 40= Plata.
Código de envasado: 0= Granel.

ALUMINIO



PERFIL 7288 Y ACCESORIOS

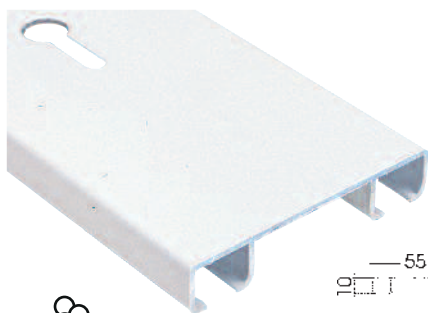

| REF. | <----> | | | 06 |
|---------|--------|------|---|----|
| 7288060 | 6 m. | x 12 | - | - |
| 7289060 | 4 m. | x 12 | - | - |
| 7290060 | 3 m. | x 12 | - | - |
| 7291060 | 2 m. | x 12 | - | - |

CORREDERA SIMPLE

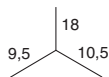

| REF. | 0906060 | 1072**0 | 1072062 |
|------|---------|---------|---------|
| | x 500 | x 400 | x 25 |
| | 06 | - | - |
| | 07 | - | - |

CORREDERA FRENTE
(Ristra 10 Unidades)

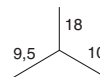

NOTA: Perforados de Ø10 cada 250 mm.

CORREDERA CON RUEDA
(Ristra 10 Unidades)

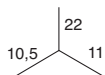
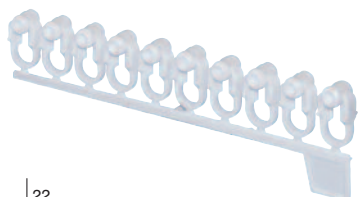

CORREDERA SIMPLE CON RUEDA

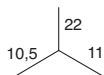

CORREDERA MAESTRA

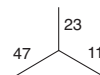

| REF. | 0689060 | 0907060 | 0907062 | 0962060 |
|------|---------|---------|---------|---------|
| | x 400 | x 500 | x 20 | x 50 |
| | 06 | - | - | - |

CORREDERA MAESTRA CON RUEDAS

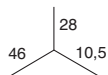
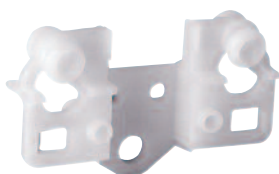

CORREDERA MAESTRA CON PATA CORTA

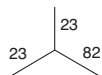

CORREDERA MAESTRA CON RUEDA
Y PATA CORTA

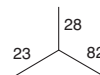

| REF. | 0953060 | 0856060 | 0851060 |
|------|---------|---------|---------|
| | x 50 | x 50 | x 50 |
| | 06 | - | - |

** Colores: 06= Blanco. 07= Negro.
Código de envasado: 0= Granel. 2= Blister.



PERFIL 7288 Y ACCESORIOS

TERMINAL PERFIL

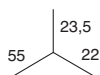
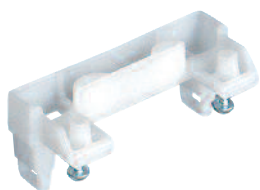

TOPE INTERMEDIO

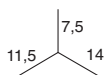

TOPE FINAL

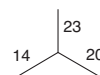

| | | | |
|------|----------------|----------------|----------------|
| REF. | 7292060 | 7293060 | 7301060 |
| | x 50 | x 50 | x 50 |
| 06 | - | - | - |

POLEA INTERMEDIA

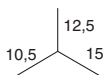

FIJADOR INTERMEDIO

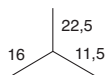

CORDÓN POLIÉSTER Ø2,5



| | | | |
|------|----------------|----------------|------------------|
| REF. | 1230400 | 0892060 | 2556060 |
| | x 50 | x 50 | Carrete x 200 m. |
| 06 | - | - | - |
| 40 | - | - | - |

TENSOR

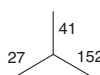

CONTRAPESO 30 grs.



CONTRAPESO CON GANCHO 50 grs.

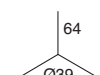

| | | | | | | |
|------|----------------|----------------|----------------|----------------|----------------|----------------|
| REF. | 0419060 | 0419062 | 0421060 | 0421062 | 0400060 | 0400062 |
| | x 25 | x 1 | x 50 | x 2 | x 25 | x 2 |
| 06 | - | - | - | - | - | - |

Colores: **06**= Blanco. **40**= Plata.
Código de envasado: **0**= Granel. **2**= Blister.

PERFIL 7288 Y ACCESORIOS

CONTRAPESO 50 grs.

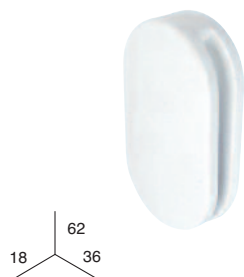

62
36
18

CONTRAPESO 70 grs.







106
14,5
31,5

CONTRAPESO 110 grs.



106
14,5
31,5

| REF. | 1237060 | 1204**0 | 1224060 |
|--|--|--|--|
| |  x 25 |  x 10 |  x 10 |
|  06 | - | - | - |
| 32 | - | - | - |

ESQUEMA DEL MONTAJE CON CORDÓN P-7288

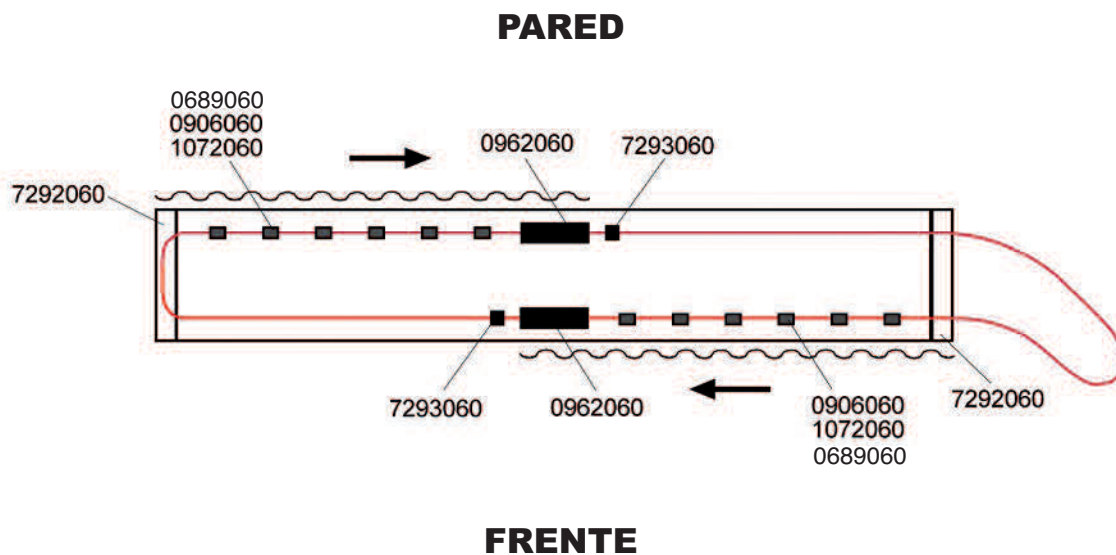

Colores: **06**= Blanco. **32**= Gris.
Código de envasado: **0**= Granel.



PERFIL 7269 Y ACCESORIOS (No admite montar con cordón)

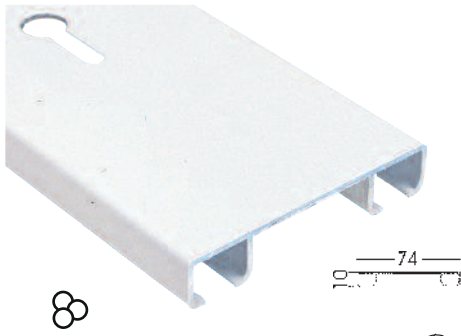

CORREDERA FRENTE
(Ristra 10 Unidades)

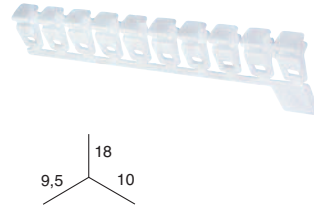

CORREDERA CON RUEDA
(Ristra 10 Unidades)

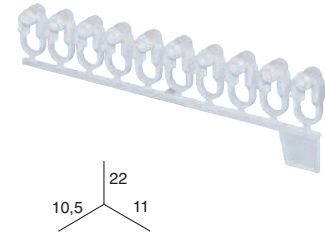

| REF. | ←----→ | | 06 |
|---------|--------|------|----|
| 7269060 | 6 m. | x 12 | - |
| 7302060 | 4 m. | x 12 | - |
| 7303060 | 3 m. | x 12 | - |
| 7304060 | 2 m. | x 12 | - |

| REF. | 1072**0 | 1072062 | 0689060 |
|------|---------|---------|---------|
| | x 400 | x 25 | x 400 |
| 06 | - | - | - |
| 07 | - | - | - |

NOTA: Perforados de Ø10 cada 250 mm.

NOTA: Disponemos de conjuntos de distintos componentes (ver en "rieles a medida")

CORREDERA SIMPLE



CORREDERA SIMPLE
CON RUEDA



CORREDERA MAESTRA

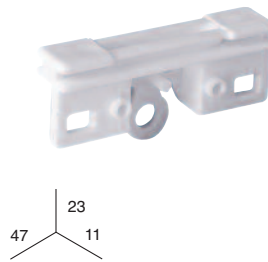

CORREDERA MAESTRA
CON RUEDAS

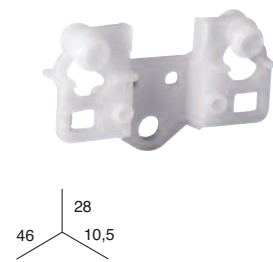

| REF. | 0906060 | 0907060 | 0907062 | 0962060 | 0953060 |
|------|---------|---------|---------|---------|---------|
| | x 500 | x 500 | x 20 | x 50 | x 50 |
| 06 | - | - | - | - | - |

CORREDERA MAESTRA
CON PATA

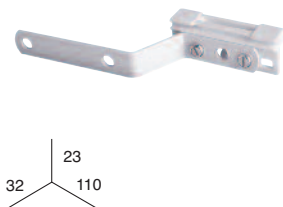

CORREDERA MAESTRA
CON RUEDA Y PATA

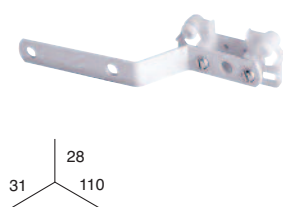

TOPE FINAL



FIJADOR INTERMEDIO



| REF. | 0913**0 | 0952**0 | 7301060 | 0892060 |
|------|---------|---------|---------|---------|
| | x 50 | x 50 | x 50 | x 50 |
| 06 | - | - | - | - |
| 40 | - | - | - | - |

Colores: 06= Blanco. 07= Negro. 40= Plata.
Código de envasado: 0= Granel. 2= Blister.

PERFIL 1078 Y ACCESORIOS

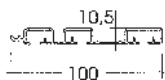
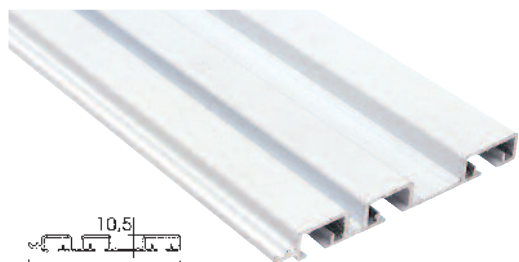

Perfil 1078, 3 vías
(para galería con P-7206)

| REF. | <-----> | | 06 |
|---------|---------|------|----|
| 1078060 | 6 m. | x 10 | - |
| 7202060 | 4 m. | x 10 | - |
| 7201060 | 3 m. | x 10 | - |
| 7200060 | 2 m. | x 10 | - |

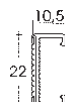

Perfil 7206

| REF. | <-----> | | 06 |
|---------|---------|------|----|
| 7206060 | 6 m. | x 50 | - |
| 7205060 | 4 m. | x 50 | - |
| 7204060 | 3 m. | x 50 | - |
| 7203060 | 2 m. | x 50 | - |

CORREDERA FRENTE
(Ristra 10 Unidades)

CORREDERA CON RUEDA
(Ristra 10 Unidades)

CORREDERA SIMPLE

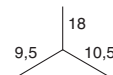
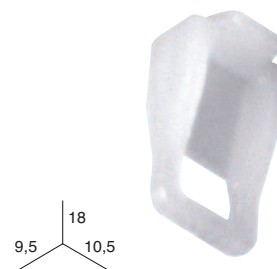
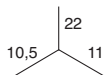
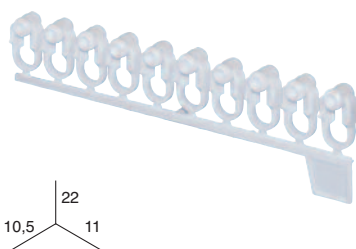
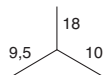
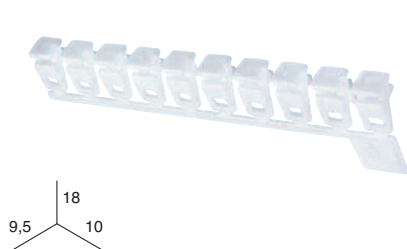

| REF. | 1072**0 | 1072062 | 0689060 | 0906060 |
|------|---------|---------|---------|---------|
| | x 400 | x 25 | x 400 | x 500 |
| 06 | - | - | - | - |
| 07 | - | - | - | - |

MONTAJE DEL PERFIL 1078 (3 VÍAS) CON GALERÍA PERFIL 7206

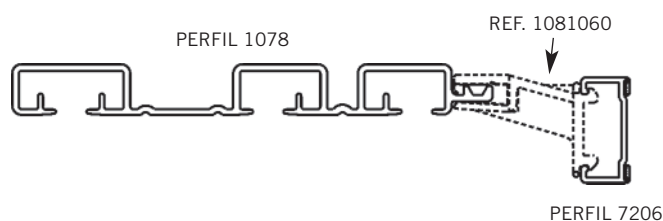

** Colores: 06= Blanco. 07= Negro.
Código de envasado: 0= Granel. 2= Blister.



PERFIL IO78 Y ACCESORIOS

CORREDERA SIMPLE CON RUEDA

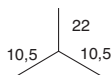
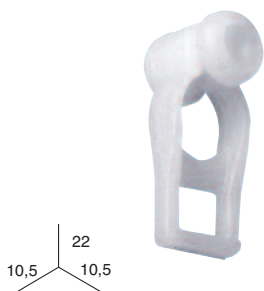

CORREDERA MAESTRA

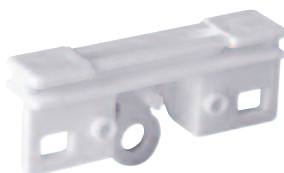

CORREDERA MAESTRA CON RUEDAS

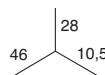

| REF. | 0907060 | 0907062 | 0962060 | 0953060 |
|------|---------|---------|---------|---------|
|------|---------|---------|---------|---------|

x 500

x 20

x 50

x 50

| | | | | |
|----|---|---|---|---|
| 06 | - | - | - | - |
|----|---|---|---|---|

CORREDERA MAESTRA CON PATA

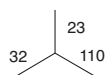

CORREDERA MAESTRA CON PATA CORTA

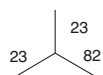

CORREDERA MAESTRA CON RUEDA Y PATA

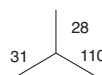

| REF. | 0913**0 | 0856060 | 0952**0 |
|------|---------|---------|---------|
|------|---------|---------|---------|

x 50

x 50

x 50

| | | | |
|----|---|---|---|
| 06 | - | - | - |
| 40 | - | - | - |

CORREDERA MAESTRA CON RUEDA Y PATA CORTA

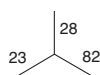

CORDÓN POLIÉSTER Ø2,5



TENSOR

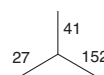
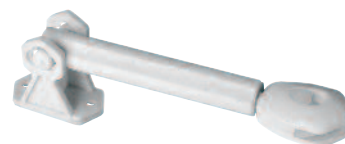

| REF. | 0851060 | 2556060 | 0419060 | 0419062 |
|------|---------|---------|---------|---------|
|------|---------|---------|---------|---------|

x 50

Carrete x 200 m.

x 25

x 1

| | | | | |
|----|---|---|---|---|
| 06 | - | - | - | - |
|----|---|---|---|---|

** Colores: 06= Blanco. 40= Plata.
Código de envasado: 0= Granel. 2= Blister.

PERFIL 1078 Y ACCESORIOS

CONTRAPESO 30 grs.



CONTRAPESO CON GANCHO 50 grs.



CONTRAPESO 50 grs.

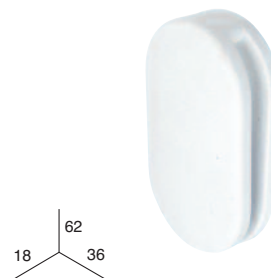

| REF. | 0421060 | 0421062 | 0400060 | 0400062 | 1237060 |
|------|---------|---------|---------|---------|---------|
|------|---------|---------|---------|---------|---------|

| | | | | |
|------|-----|------|-----|------|
| x 50 | x 2 | x 25 | x 2 | x 25 |
|------|-----|------|-----|------|

| | | | | | |
|----|---|---|---|---|---|
| 06 | - | - | - | - | - |
|----|---|---|---|---|---|

CONTRAPESO 70 grs.

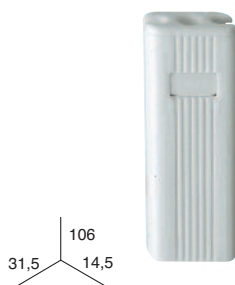

CONTRAPESO 110 grs.

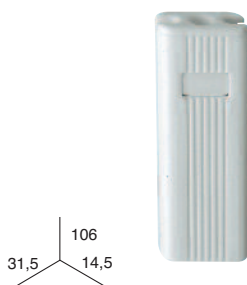

TAPÓN

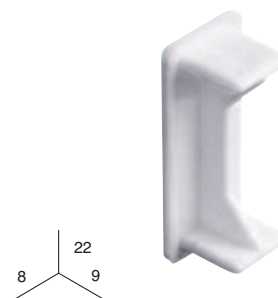

| REF. | 1204**0 | 1224060 | 1521060 |
|------|---------|---------|---------|
|------|---------|---------|---------|

| | | |
|------|------|------|
| x 10 | x 10 | x 50 |
|------|------|------|

| | | | |
|----|---|---|---|
| 06 | - | - | - |
| 32 | - | - | - |

TERMINAL IZQUIERDA Y DERECHA

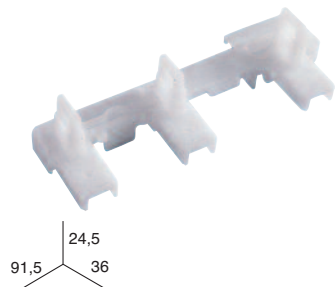

SOPORTE PERFIL 7206 A PERFIL 1078



UNIÓN ESQUINA TECHO, PARED PERFIL 7206

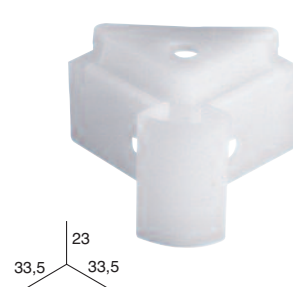

| REF. | 1080060 | 1081060 | 7210060 |
|------|---------|---------|---------|
|------|---------|---------|---------|

| | | |
|-------------|------|------|
| x 12 juegos | x 25 | x 25 |
|-------------|------|------|

| | | | |
|----|---|---|---|
| 06 | - | - | - |
|----|---|---|---|

** Colores: 06= Blanco. 32= Gris.
Código de envasado: 0= Granel. 2= Blister.



PERFIL 1129 / 1131 Y ACCESORIOS (No admite montar con cordón)

PERFIL 1129, 3 VÍAS (PERFORADO)

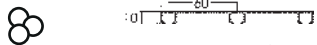

REF. <----> 06

1129060 6 m. x 8 -

1179060 4 m. x 8 -

PERFIL 1131, 3 VÍAS (SIN PERFORAR)

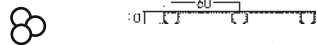
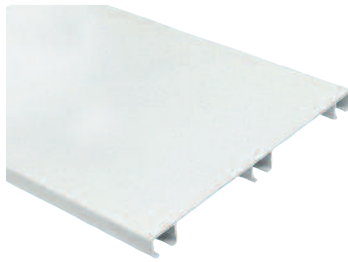

REF. <----> 06

1131060 6 m. x 8 -

1178060 4 m. x 8 -

CORREDERA FRENTE (Ristra 10 Unidades)

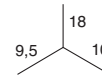

REF. **1072**0** **1072062**

x 400 x 25

06 - -
07 - -

NOTA: Perforados de Ø10 cada 125 mm.

CORREDERA CON RUEDA (Ristra 10 Unidades)

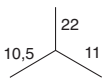
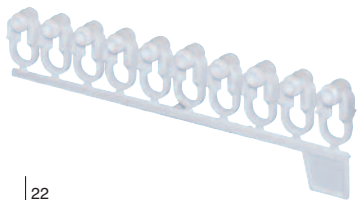

REF. **0689060** **0906060** **0907060** **0907062**

x 400

x 500

x 500

x 20

06 - - - -

CORREDERA SIMPLE

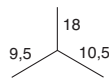

CORREDERA SIMPLE CON RUEDA

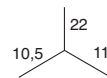

CORREDERA MAESTRA

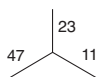
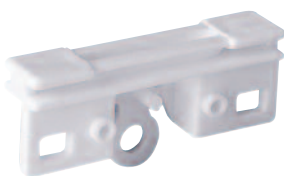

CORREDERA MAESTRA CON RUEDAS

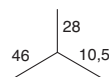
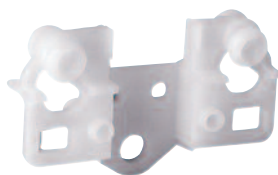

CORREDERA MAESTRA CON PATA

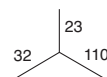

REF. **0962060** **0953060** **0913**0**

x 50

x 50

x 50

06 - - -
40 - - -

** Colores: 06= Blanco. 07= Negro. 40= Plata.
Código de envasado: 0= Granel. 2= Blister.



PERFIL I129 / I131 Y ACCESORIOS

CORREDERA MAESTRA CON PATA CORTA

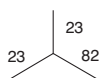

CORREDERA MAESTRA CON RUEDA Y PATA

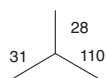

CORREDERA MAESTRA CON RUEDA Y PATA CORTA

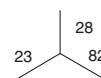

| REF. | 0856060 | 0952**0 | 0851060 |
|------|---------|---------|---------|
|------|---------|---------|---------|

x 50

x 50

x 50

| | | | |
|----|---|---|---|
| 06 | - | - | - |
| 40 | - | - | - |

TOPE FINAL

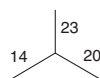

FIJADOR INTERMEDIO

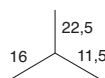

TOPE Y GUÍA HILOS

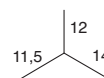

| REF. | 7301060 | 0892060 | 1560060 |
|------|---------|---------|---------|
|------|---------|---------|---------|

x 50

x 50

x 50

| | | | |
|----|---|---|---|
| 06 | - | - | - |
|----|---|---|---|

ESQUEMA DE MONTAJE SIN CORDÓN P-I129/I131

PARED

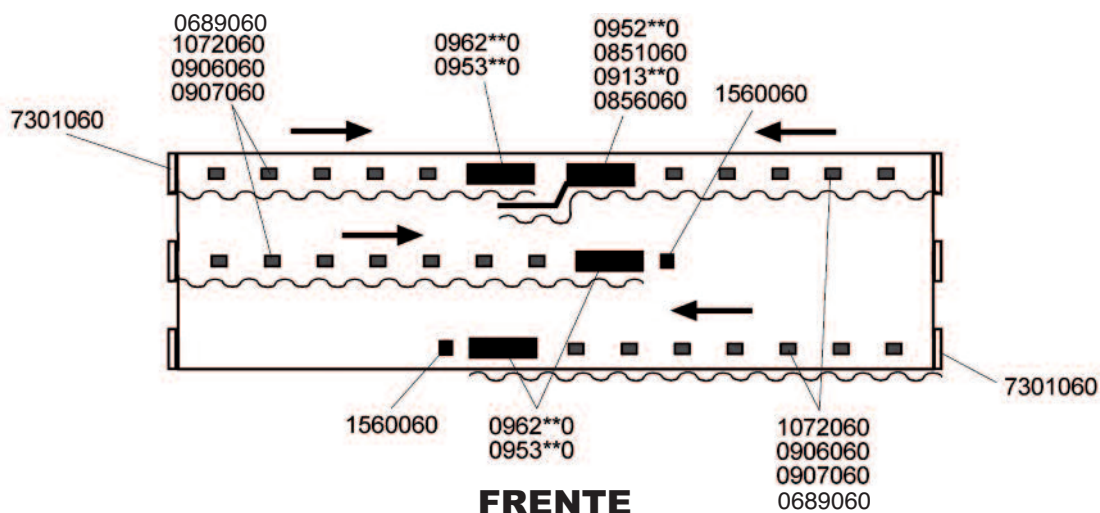

FRENTE

** Colores: 06= Blanco. 40= Plata.
Código de envasado: 0= Granel.



PERFIL 909 Y ACCESORIOS PARA GALERÍA

PERFIL 909

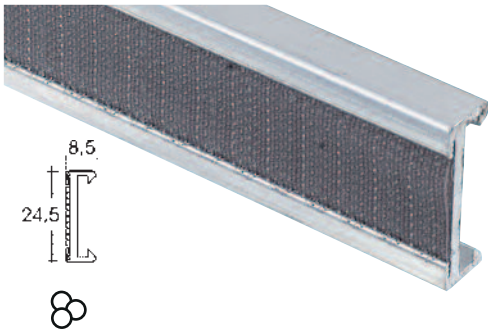

CINTA FELPA VELOUR SIN ADHESIVO



EMPALME

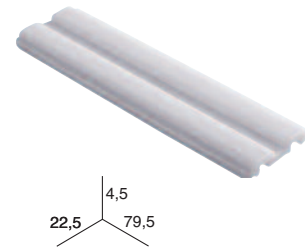

| REF. | <----> | | | 40 |
|---------|--------|------|---|----|
| 0909400 | 6 m. | x 50 | - | - |
| 1090400 | 4 m. | x 50 | - | - |
| 1089400 | 3 m. | x 50 | - | - |
| 1088400 | 2 m. | x 50 | - | - |

| REF. | 0991**0 | 0824060 |
|------|-----------------|---------|
| | Carrete x 25 m. | x 25 |
| 06 | - | - |
| 07 | - | - |
| 32 | - | - |

TAPÓN



UNIÓN ESQUINA
TECHO, PARED

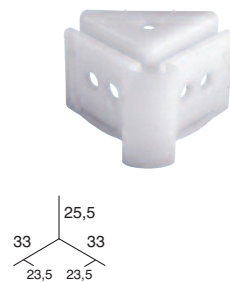

SOPORTE ESTOR
FRENTE-TECHO

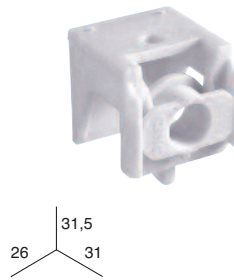

ESTRIBO

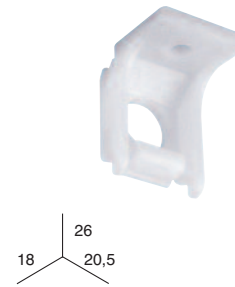

| REF. | 0801060 | 1060060 | 0800060 | 0990060 |
|------|---------|---------|---------|---------|
| | x 50 | x 25 | x 50 | x 50 |
| 06 | - | - | - | - |

PERFIL 1076 Y 7198 y ACCESORIOS PARA GALERÍA

PERFIL 1076 (CON CINTA GANCHO)

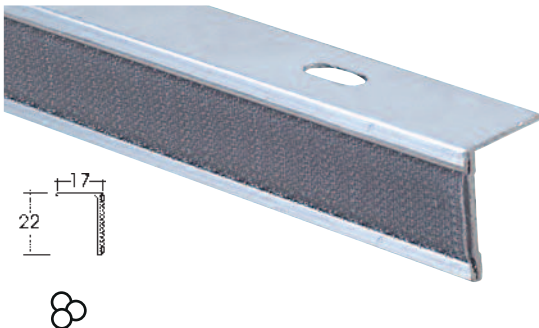

PERFIL 7198 (CON CINTA GANCHO)

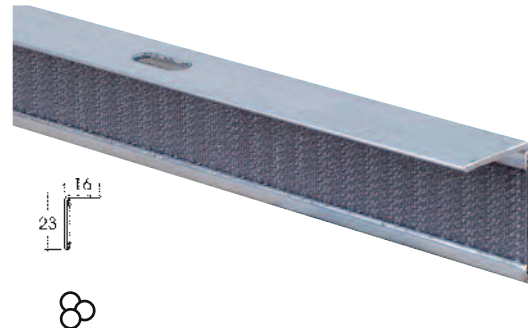

| REF. | <----> | | | 06 | 40 |
|---------|--------|------|---|----|----|
| 1076**0 | 6 m. | x 50 | - | - | - |
| 7209**0 | 4 m. | x 50 | - | - | - |
| 7208**0 | 3 m. | x 50 | - | - | - |
| 7207**0 | 2 m. | x 50 | - | - | - |

| REF. | <----> | | | 06 | 40 |
|---------|--------|------|---|----|----|
| 7198**0 | 6 m. | x 50 | - | - | - |
| 7196**0 | 4 m. | x 50 | - | - | - |
| - | - | - | - | - | - |
| - | - | - | - | - | - |

NOTA: Perforados de 12x5 cada 200 mm.

NOTA: Perforados de 12x5 cada 200 mm.

Colores: 06= Blanco. 07= Negro. 32= Gris. 40= Plata.
Código de envasado: 0= Granel.



PERFIL 7206 Y ACCESORIOS

PERFIL 7206 (CON CINTA GANCHO)



CINTA FELPA VELOUR SIN ADHESIVO



SOPORTE ESTOR FRENTE-TECHO

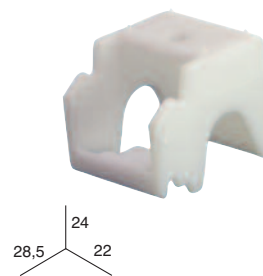

| REF. | <----> | | 40 |
|---------|--------|------|----|
| 7206060 | 6 m. | x 50 | - |
| 7205060 | 4 m. | x 50 | - |
| 7204060 | 3 m. | x 50 | - |
| 7203060 | 2 m. | x 50 | - |

| REF. | 0991**0 | 7299060 |
|------|-----------------|---------|
| | Carrete x 25 m. | x 50 |
| | 06 | - |
| | 07 | - |
| | 32 | - |

SOPORTE ESTOR FRENTE-TECHO

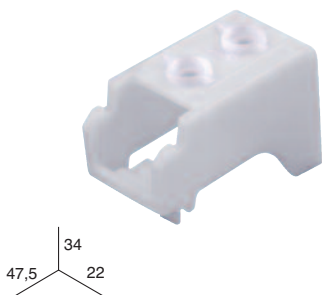

UNIÓN ESQUINA
TECHO, PARED PERFIL 7206

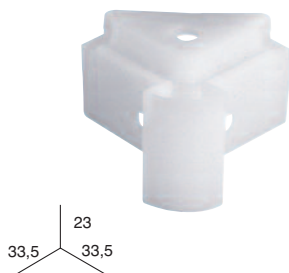

TAPÓN

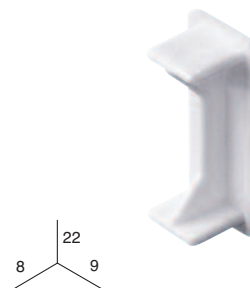

| REF. | 1540060 | 7210060 | 1521060 |
|------|---------|---------|---------|
| | x 25 | x 25 | x 50 |
| | 06 | - | - |

ALUMINIO



ACCESORIOS COMUNES

SOPORTE 3 cm. SIN ESTRIBO



SOPORTE 6 cm. SIN ESTRIBO



SOPORTE DOBLE 3-9 cm. SIN ESTRIBO



| REF. | 0770060 | 0771060 | 7187060 |
|------|---------|---------|---------|
| | x 50 | x 50 | x 50 |
| 06 | - | - | - |

SOPORTE 3 cm. CON ESTRIBO



SOPORTE 6 cm. CON ESTRIBO



SOPORTE DOBLE 3-9 cm. CON ESTRIBO



| REF. | 0901**0 | 0902**0 | 0903**0 |
|------|---------|---------|---------|
| | x 50 | x 50 | x 50 |
| 06 | - | - | - |
| 40 | - | - | - |

SOPORTE REFORZADO 3 cm.
SIN ESTRIBO



SOPORTE REFORZADO 6 cm.
SIN ESTRIBO



SOPORTE DOBLE REFORZADO 3-9 cm.
SIN ESTRIBO



| REF. | 0808**0 | 0809**0 | 0943**0 |
|------|---------|---------|---------|
| | x 50 | x 50 | x 50 |
| 06 | - | - | - |
| 40 | - | - | - |

** Colores: 06= Blanco. 40= Plata.
Código de envasado: 0= Granel.



ACCESORIOS COMUNES

SOPORTE REFORZADO 3 cm.
CON ESTRIBO

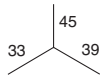

SOPORTE REFORZADO 6 cm.
CON ESTRIBO

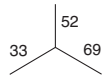

SOPORTE DOBLE REFORZADO 3-9 cm.
CON ESTRIBO

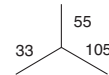

| REF. | 0818**0 | 0818**2 | 0819**0 | 0819**2 | 0960**0 | 0960**2 |
|------|---------|---------|---------|---------|---------|---------|
|------|---------|---------|---------|---------|---------|---------|



x 50



x 2



x 50



x 2



x 50

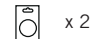

x 2



06
40

-

-

-

-

-

-

SOPORTE REFORZADO TRIPLE

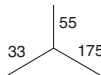

PLACA EXTENSIÓN

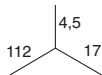

SOPORTE DE PERFIL DE ALUMINIO 10 cm.

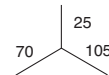

| REF. | 0854**0 | 0961**0 | 0961**2 | 7199060 |
|------|---------|---------|---------|---------|
|------|---------|---------|---------|---------|

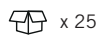

x 25



x 50



x 2



x 50

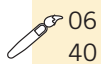

06
40

-

-

-

-

SOPORTE DE PERFIL DE ALUMINIO 15 cm.

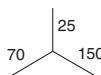

SOPORTE DE PERFIL DE ALUMINIO 19 cm.

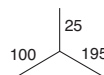

SOPORTE DE PERFIL DE ALUMINIO 24 cm.

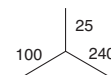

| REF. | 7229060 | 7230060 | 7231060 |
|------|---------|---------|---------|
|------|---------|---------|---------|



x 50

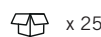

x 50



x 50



06

-

-

-

** Colores: 06= Blanco. 40= Plata.
Código de envasado: 0= Granel. 2= Blister.



ACCESORIOS COMUNES

SOPORTE DE PERFIL DE ALUMINIO
15 cm. BASE LARGA

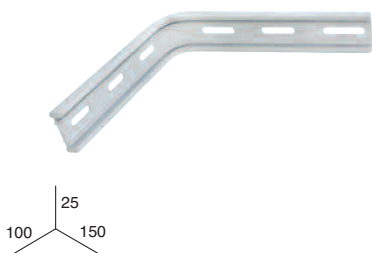

REF. **7226060**

x 25

SUPLEMENTO PARA SOPORTES

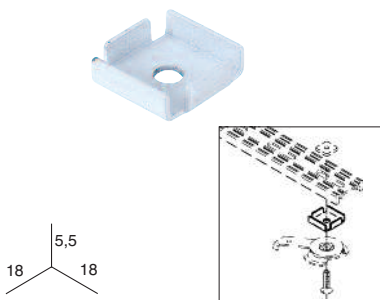

REF. **0898060**

x 25

SOPORTE TECHO DOBLE
(para ref. 0993060)

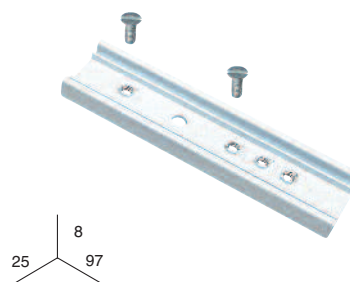

REF. **7275060**

x 25



-

-

-

SOPORTE TECHO TRIPLE
(para ref. 0993060)

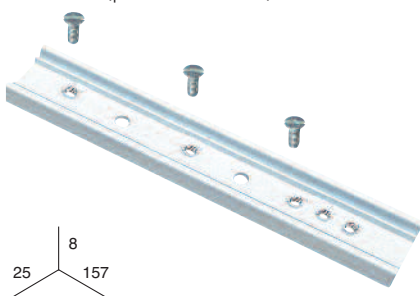

REF. **7276060**

x 25

SOPORTE TECHO "CHYC" (0,70 m.)
(Para perfiles 900, 908, 910 y 950)

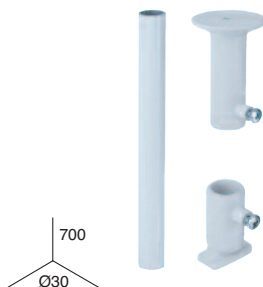

REF. **0963**0**

x 25

SOPORTE TECHO "CHYC" (1,00 m.)
(Para perfiles 900, 908, 910 y 950)

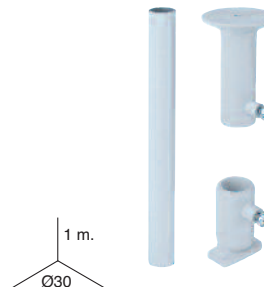

REF. **0654060**

x 25



-

-

-

CASQUILLO RIOSTRA
(Para perfiles 900, 908, 910 y 950)



REF. **0744060**

x 6 juegos

TUBO PARA CASQUILLO RIOSTRA



(3,00 m.) A medida

REF. **0437060** **0437064**

x 10

MONTAJE CASQUILLO RIOSTRA + TUBO



SENCILLO

DOBLE



-

-

-

** Colores: 06= Blanco. 40= Plata.
Código de envasado: 0= Granel.

ACCESORIOS COMUNES

SOPORTE UNIVERSAL PARA VENTANAS

Ejemplo de aplicación:



NOVEDAD



| | 0402**0 | 0402**2 |
|----|---------|---------|
| | x 10 | x 2 |
| 06 | - | - |
| 07 | - | - |
| 32 | - | - |

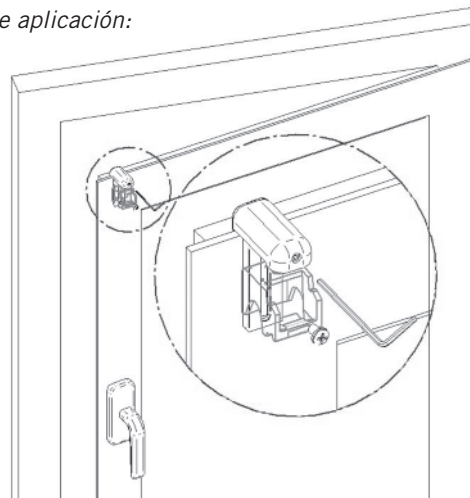





Nota: (espesor mínimo de la zona de anclaje 5 mm, espesor máximo 20 mm)

BALANCÍN

TOPE PORTATELA FIJO

SILICONA EN SPRAY 500 ml.







| REF. | 0934400 | 0917400 | 1888060 |
|------|---------|---------|---------|
| | x 25 | x 100 | x 12 |
| 40 | - | - | - |

MÁQUINA PARA CURVAR PERFIL DE ALUMINIO (Con almas para curvar)

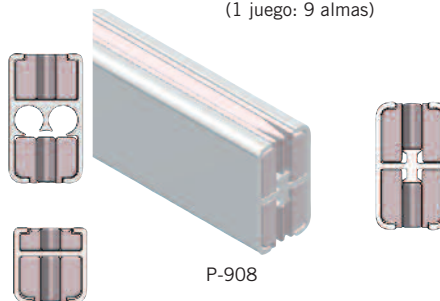
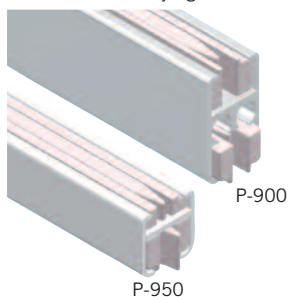
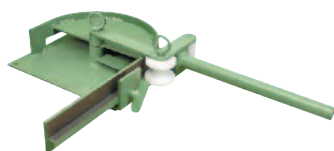
ALMAS PARA CURVAR PERFILES 900 Y 950 (1 juego: 9 almas)

ALMAS PARA CURVAR PERFILES 908 (1 juego: 9 almas)



Radio interior: 125 mm.

| REF. | 0563310 | 0513000 | 0514000 |
|------|---------|-----------|-----------|
| | x 1 | x 1 juego | x 1 juego |
| | - | - | - |

** Colores: 06= Blanco. 07= Negro. 32= Gris. 40= Plata.
Código de envasado: 0= Granel. 2= Blister.



TIRADORES DE METACRILATO

TIRADOR Ø12 mm. x 0,75 m. PUNTA BISELADA. METACRILATO



| REF. | | € |
|---------|------|---|
| 7217200 | x 25 | - |

TIRADOR Ø12 mm. x 0,75 m. CON MANGO. METACRILATO



| REF. | | € |
|---------|------|---|
| 7232200 | x 25 | - |

TIRADOR Ø15 mm. x 0,75 m. PUNTA BISELADA. METACRILATO



| REF. | | € |
|---------|------|---|
| 7227200 | x 25 | - |

TIRADOR OCTOGONAL Ø15 mm. x 0,75 m. PUNTA ESFÉRICA. METACRILATO



| REF. | | € |
|---------|------|---|
| 7233200 | x 25 | - |

Colores: **20**= Transparente.
Código de envasado: **0**= Granel.



TIRADORES DE FIBRA, ALUMINIO Y PLASTICO

NOVEDAD

TIRADOR DE FIBRA Ø10 mm. BLANCO



| | 1,00 m. | 1,25 m. | 1,50 m. | 1,75 m. | 2,00 m. |
|------|----------------|----------------|----------------|----------------|----------------|
| REF. | 0728060 | 0727060 | 0722060 | 0723060 | 0724060 |
| | x 25 | x 25 | x 25 | x 25 | x 25 |
| 06 | - | - | - | - | - |

NOVEDAD

TIRADOR DE ALUMINIO



| | 1,00 m. | 1,25 m. | 1,50 m. | 1,75 m. | 2,00 m. |
|------|----------------|----------------|----------------|----------------|----------------|
| REF. | 0726060 | 0725060 | 0697060 | 0717060 | 0718060 |
| | x 25 | x 25 | x 25 | x 25 | x 25 |
| 06 | - | - | - | - | - |

TIRADOR PLASTIFICADO



| | 0,75 m. | | 1,00 m. | | 1,25 m. | 1,50 m. |
|------|----------------|----------------|----------------|----------------|----------------|----------------|
| REF. | 0847**0 | 0847**2 | 0992**0 | 0992**2 | 0998060 | 0946060 |
| | x 25 | x 2 | x 25 | x 2 | x 25 | x 25 |
| 06 | - | - | - | - | - | - |
| 07 | - | - | - | - | - | - |

Colores: **06**= Blanco. **07**= Negro.
Código de envasado: **0**= Granel.

GAMA DE MOTORIZACIÓN DE CORTINAS "GLYDEA"



RIEL CHYC, incluye en su catálogo, la línea de rieles motorizados de la acreditada marca **SOMFY**, referente en el mercado internacional en automatismos de interior y exterior.



Las cortinas motorizadas se están convirtiendo en una característica habitual de los proyectos con estilo, ya sean hoteles de calidad, viviendas o centros de reuniones y conferencias a los que aportan imagen y funcionalidad.



Glydea es robusto, cómodo, fiable y permite soluciones personalizadas de vanguardia. **Glydea** mejora la imagen de un centro de reunión y hace que el trabajo del personal sea más fácil.



En su versión automática contribuye a lograr ahorro energético y seguridad, ampliando la duración de las cortinas.

La flexibilidad de este conjunto es, sin duda, su mejor cualidad porque permite ofrecer todas las soluciones para responder a los proyectos más exigentes. Detallamos las propiedades derivadas de esta flexibilidad:

- **Adaptabilidad:** permite la personalización del producto con un solo riel para distintos tipos y formas de cortina.

TIPOS DE CORTINA

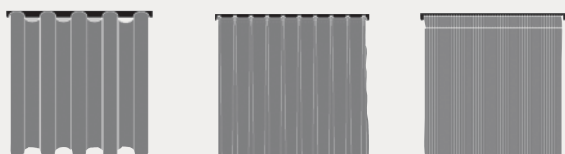

TIPOS DE APERTURA: LATERAL Y CENTRAL



- **Dos tipos de motorización y gran variedad de sistemas de control.**

| | MOTOR | APERTURA LATERAL | APERTURA CENTRAL |
|--|-------------------|------------------|------------------|
| | GLYDEA™ 35 | 35 Kg. / 10 m. | 35 Kg. / 10 m. |
| | GLYDEA™ 60 | 60 Kg. / 10 m. | 60 Kg. / 10 m. |

| | | |
|--|--|---|
| | | |
| <p>Compatibilidades estándar. Motores WT.</p> <ul style="list-style-type: none"> • Automatización para hoteles u hogares, relés de conmutación de CA o contacto seco. • Inversores y sistemas de control de CA del mercado. • Inversores de doble o triple botón. • Transmisores por infrarrojos. | <p>Glydea™ puede equiparse con módulos conectables para interactuar con tecnologías de control adicionales. Motores DCT.</p> <p>Receptores RTS, compatibilidad con todos los controles Somfy RTS.</p> | <p>Módulo RS485, para interactuar con los sistemas de comunicación de automatización domésticos más habituales.</p> |

- **Instalación fácil:** ocultación de motor en falsos techos, posición a derecha o a izquierda, final de carrera ajustable, soporte de techo One Touch o giratorio (ver esquema en páginas posteriores), transformador de 24V integrado.

MONTAJE ESTÁNDAR



MONTAJE EN FALSO TECHO



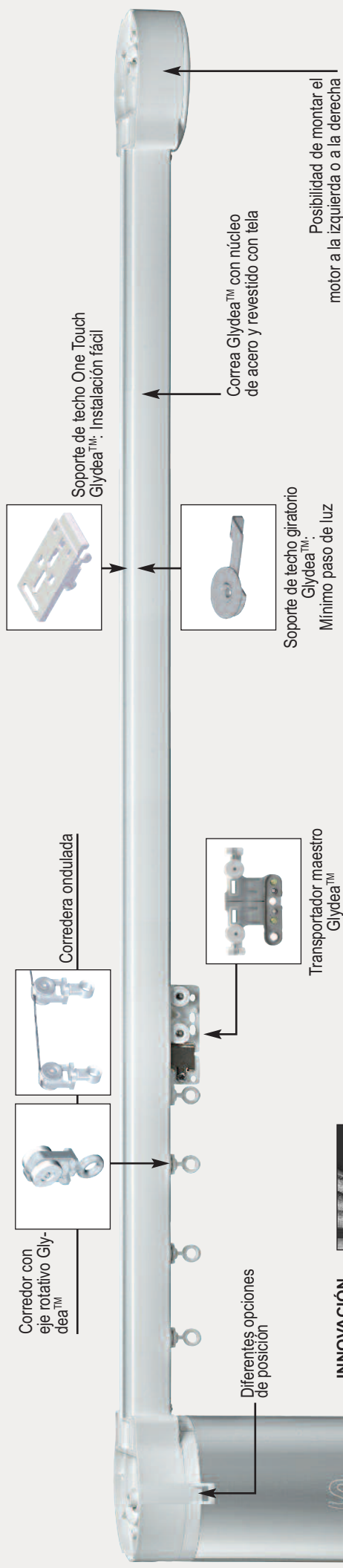

La sofisticación de este riel se refleja en sus formas sencillas y las líneas elegantes del motor y el perfil.

Estética

- Mínimo espacio de luz gracias al diseño del riel y al soporte de techo giratorio.
- Opción de finales de carrera ajustables.
- Bajo nivel de ruido del riel motorizado (<44 dB(A), con arranque y parada suaves).

Innovación

- El diseño patentado de la cubierta del perfil oculta el cableado y protege los conectores y los módulos de control dentro del motor.
- Módulos de gestión conectables para una gran variedad de sistemas de control.
- Posibilidad de accionamiento manual que desacopla automáticamente el eje de accionamiento del motor para un funcionamiento manual, preservando la tela.

Eficiencia

- Función "Touch Motion", para abrir y cerrar la cortina simplemente tirando de la tela.
- Función "My", para llevar automáticamente la cortina hasta una posición preferida.
- Velocidad ajustable: de 12,5 cm/s a 20 cm/s.

Diseño resistente y flexibilidad

- Botones de ajuste y cableado no accesibles para el usuario final.
- No se necesita mantenimiento tras la instalación.
- Extensa variedad de componentes para adaptarse a diferentes tipos de tejido.
- Testado para un funcionamiento de más de 5.000 ciclos.

Calidad

- CHYC garantiza este producto durante 5 años, contando con la garantía internacional de SOMFY.
- Esta gama cuenta con las certificaciones internacionales siguientes:



INNOVACIÓN SOMFY
Posibilidad de accionamiento manual



Diseño de cubierta sobrio
— Función Touch Motion
— Función My (posición preferida)
— Transformador integrado



INNOVACIÓN SOMFY

Flexibilidad de control



Especificaciones técnicas

1. Cuadro de la características

| MOTOR | GLYDEA™ 35 DCT | GLYDEA™ 35 WT | GLYDEA™ 60e DCT | GLYDEA™ 60e WT |
|--|----------------|---------------|-----------------|----------------|
| Características principales del motor | | | | |
| Arranque suave | ● | ● | ● | ● |
| Parada suave | | | ● | ● |
| Posición intermedia | | | ● | |
| Funcionamiento manual | ● | ● | ● | ● |
| Touch Motion | | | ● | |
| Finales de carrera automáticos | ● | ● | ● | ● |
| Back Release | ● | ● | | ● |
| Límites ajustables | | | ● | |
| Velocidad ajustable | | | ● | ● |
| Opciones de control | | | | |
| Conmutación de CA | | ● | | ● |
| 3 contactos secos normalmente abiertos | ● | | ● | |
| 2 contactos secos normalmente abiertos | ● | | ● | |
| 2 contactos secos normalmente abiertos modo cíclico | ● | | ● | |
| Control principal y de grupo e individual de contacto seco | ● | | ● | |
| Infrarrojos | ● | | ● | |
| Tandem (próximamente) | | | ● | |
| Tecnología digital RS485 (primer semestre 2012) | ● | | ● | |
| Radio Tecnología Somfy (RTS) | ● | | ● | |
| Control solar | ● | | ● | |
| Control horario | ● | ● | ● | ● |
| Características de ajustes e instalación | | | | |
| Ajuste con botones a través del motor | | | ● | ● |
| Indicadores LED | | | ● | ● |
| Cambio de sentido de giro del motor | ● | ● | ● | ● |
| Montaje invertido | ● | ● | ● | ● |

Características principales del riel motorizado

| MOTOR | GLYDEA™ 35 DCT | GLYDEA™ 35 WT | GLYDEA™ 60e DCT | GLYDEA™ 60e WT |
|--|---------------------------------|------------------|--------------------------|--------------------------|
| Rango de voltaje | 250 V 50 HZ | 250 V 50 HZ | 250 V 50 HZ | 250 V 50 HZ |
| Velocidad lineal media de | 20 cm/s | 20 cm/s | 12,5 / 15 / 17 / 20 cm/s | 12,5 / 15 / 17 / 20 cm/s |
| Consumo eléctrico | 60 W | 60 W | 120 W | 120 W |
| Tipo de cable de alimentación | Cable de 3 hilos | Cable de 4 hilos | Cable de 3 hilos | Cable de 4 hilos |
| Conector de control | RJ12 | | RJ12 | |
| Voltaje en la línea de control DCT (suministrado por el motor) | 3,3 VDC | 250 V CA | 3,3 VDC | 250 V CA |
| Nivel de ruido del riel motorizado ⁽¹⁾ | 50 dB(A) | 50 dB(A) | 44 dB(A) ⁽²⁾ | 44 dB(A) ⁽²⁾ |
| Certificaciones | c TUV us, CCC, CE, C-Tick, SASO | | | |
| Longitud máxima de riel | 10 m | 10 m | 10 m | 10 m |
| Número máximo de uniones | 2 | 2 | 2 | 2 |

⁽¹⁾ Nivel de presión de sonido de acuerdo con la norma de medición de Somfy.

⁽²⁾ A 15 cm/s.

2. Dimensiones del motor

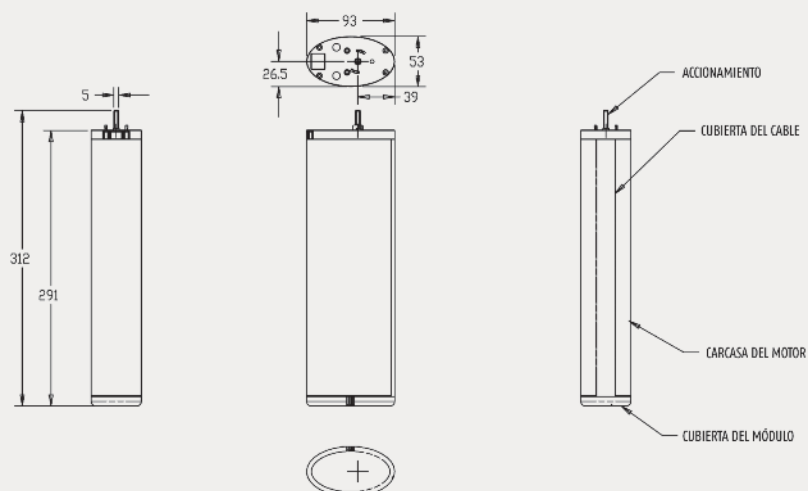

3. Tipos de montaje

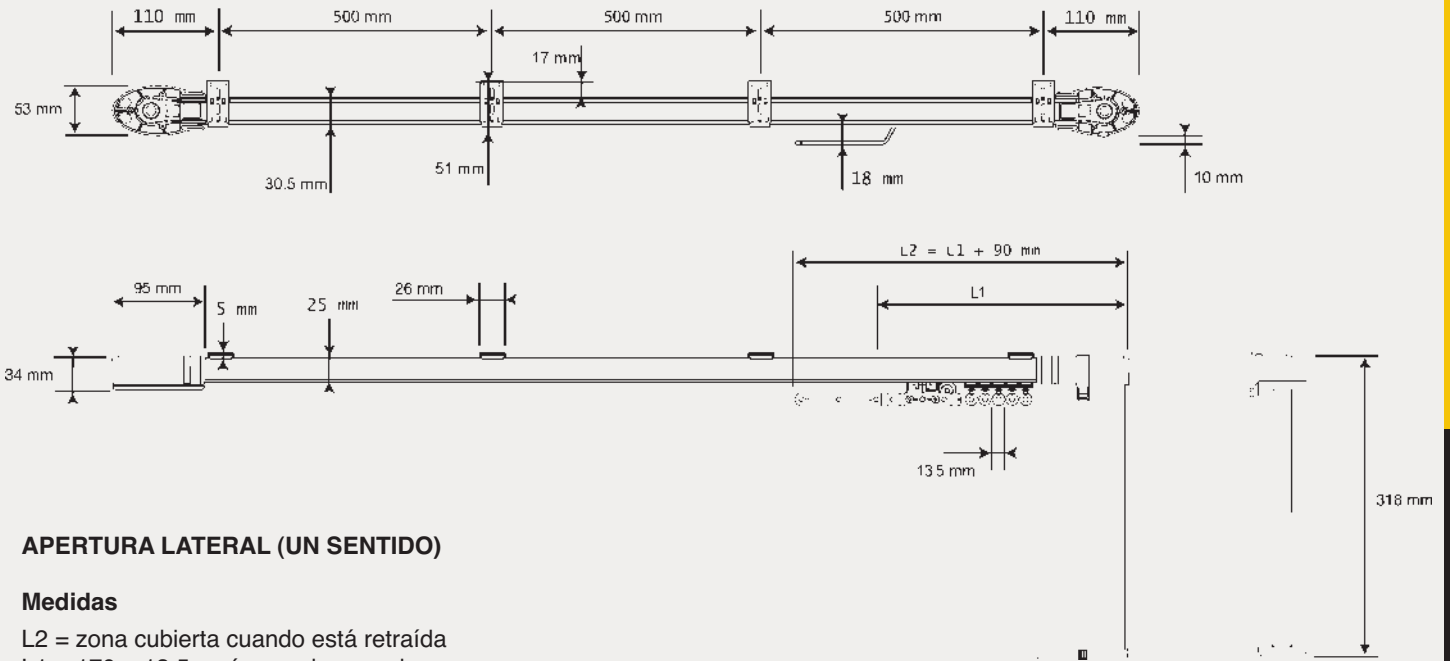

APERTURA LATERAL (UN SENTIDO)

Medidas

L2 = zona cubierta cuando está retraída
 L1 = 170 + 13.5 x número de corredores
 L2 = L1 + 90 mm

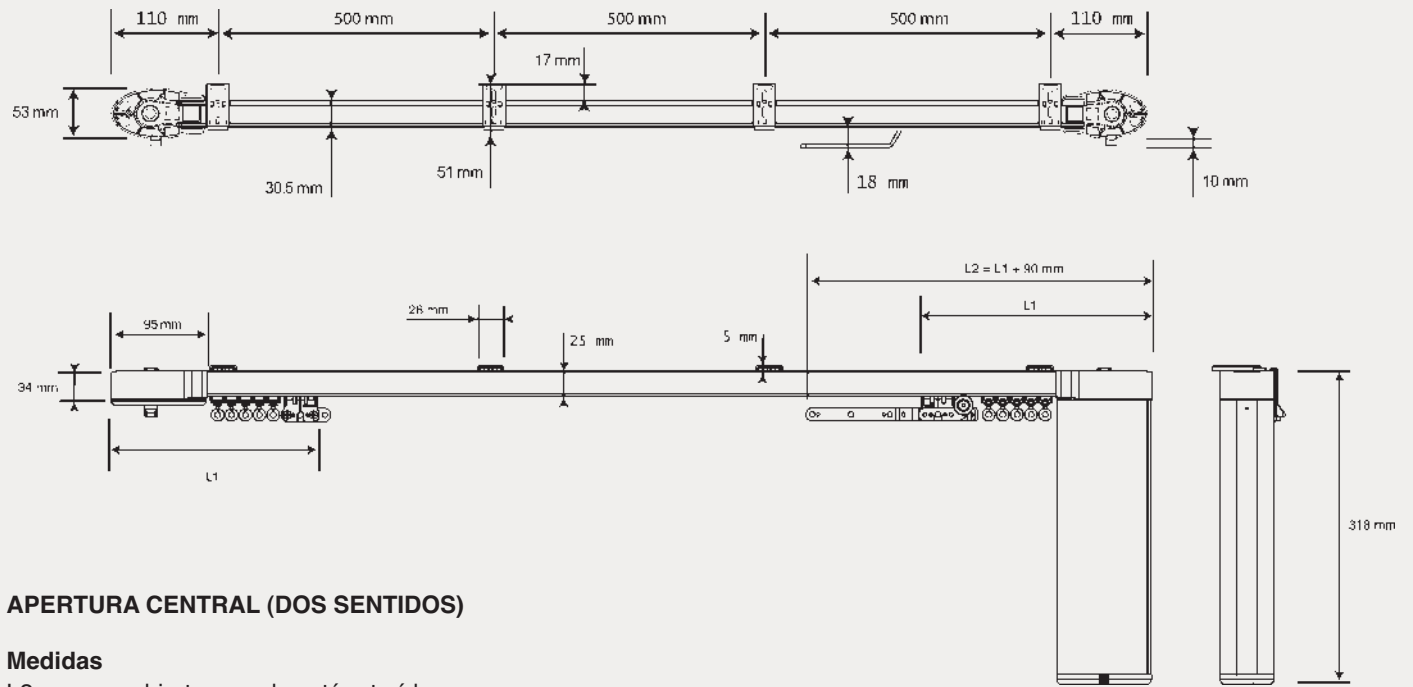

APERTURA CENTRAL (DOS SENTIDOS)

Medidas

L2 = zona cubierta cuando está retraída
 L1 = 170 + 13.5 x número de corredores
 L2 = L1 + 90 mm

NOTA: Para montajes de cortina ondulada, consultar.

Tipos y dimensiones de soportes

4. Soportes

SOPORTE DE TECHO ONE TOUCH

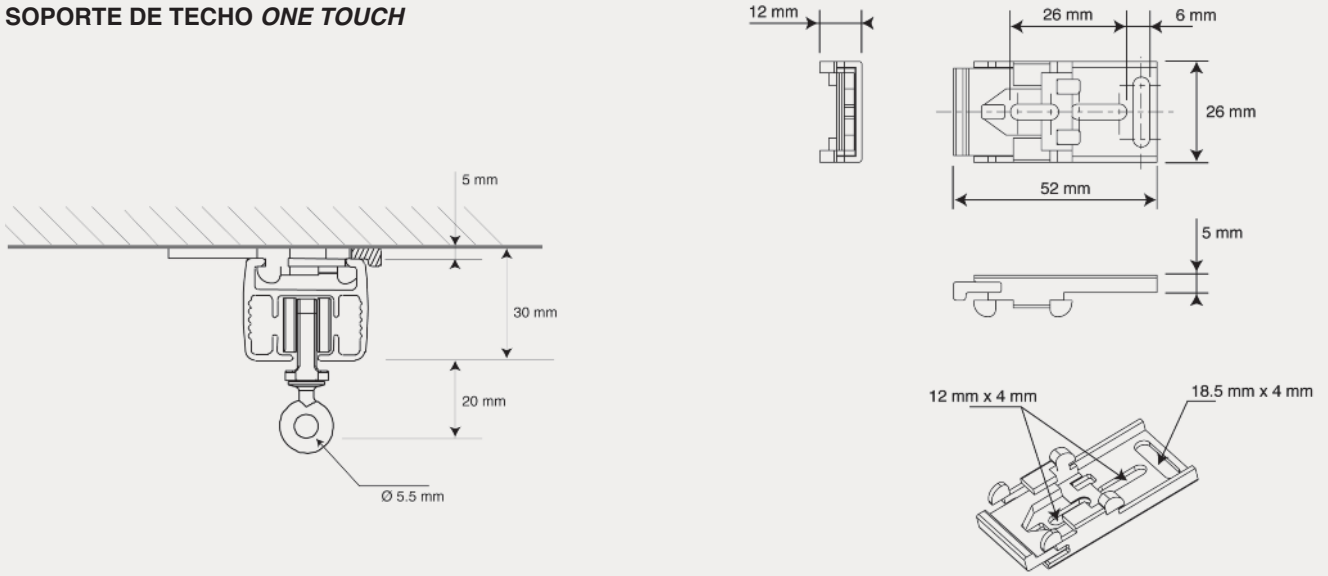

SOPORTE DE TECHO GIRATORIO

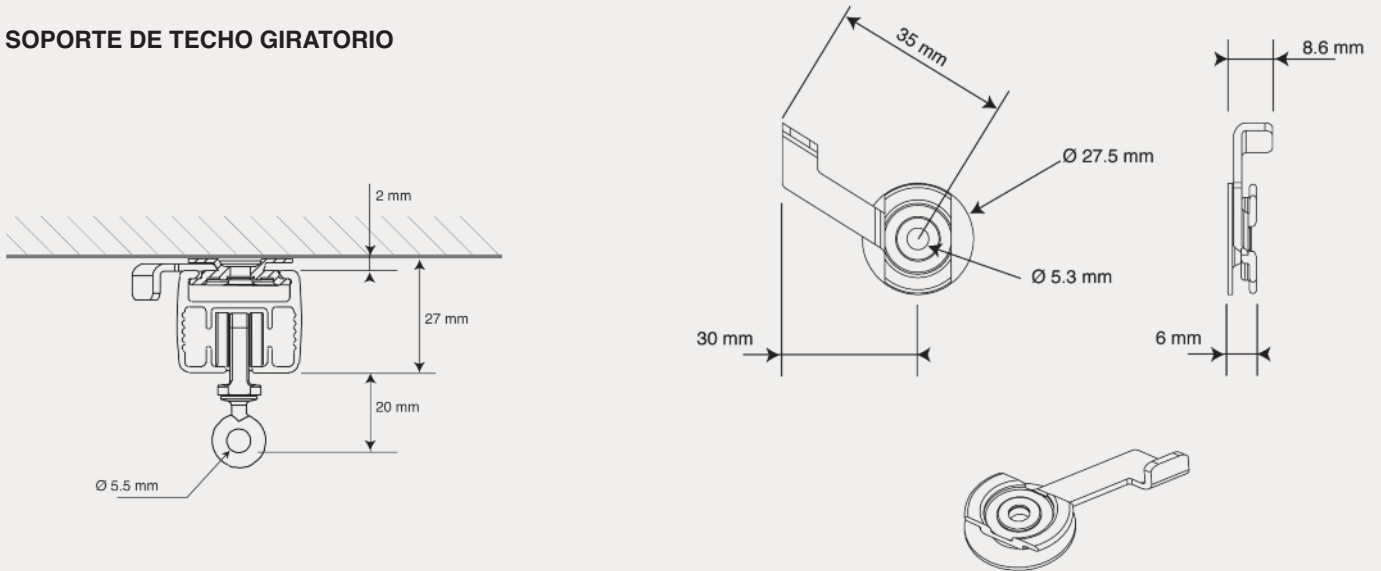

SOPORTE DE PARED AJUSTABLE

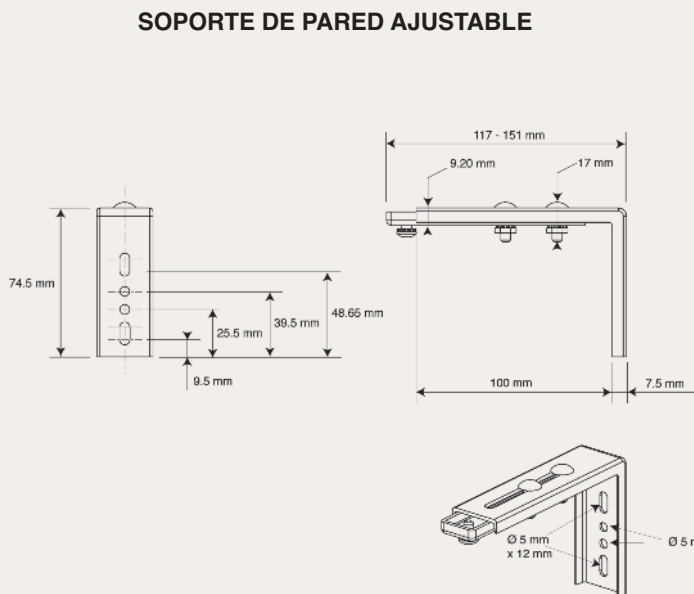

SOPORTE DOBLE DE PARED AJUSTABLE

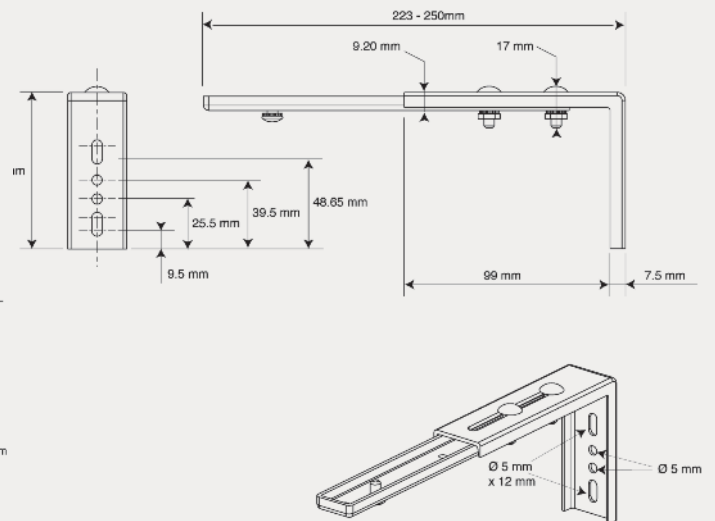

Configuración de los componentes necesarios y adecuados para el montaje del riel

Seguiremos los pasos siguientes para configurar el riel atendiendo a las características del montaje:

PASO 1: Selección del motor

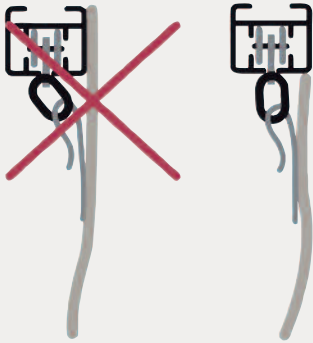

Colocación correcta para evitar rozamientos y daños en el tejido y en el riel motorizado.

La elección del motor requiere determinar la capacidad de carga necesaria. Para ello tendremos en cuenta los siguientes factores:

- El tipo de apertura y longitud del riel.
- Peso de la cortina: Kg/m² de tela x m² de cortina.
- Capacidad de movimiento transversal, referente a la existencia de rozamiento por contacto de la tela con el riel o con el dosel del riel. Es importante una correcta colocación (ver dibujo).

|  | MOTOR | REFERENCIA |
|---|---|------------|
| | MOTOR 35 DCT: Contacto seco, unidad de cable de 1,5 m de 3 hilos (Para cortinas con peso hasta 35 kg.) | 8064000 |
| | MOTOR 35 WT: Control de conmutación CA, unidad de cable de 1,5 m de 4 hilos (Para cortinas con peso hasta 35 kg.) | 8065000 |
| | MOTOR 60 DCT: Contacto seco, unidad de cable de 1,5 m de 3 hilos (Para cortinas con peso hasta 60 kg.) | 8066000 |
| | MOTOR 60 WT: Control de conmutación CA, unidad de cable de 1,5 m de 4 hilos (Para cortinas con peso hasta 60 kg.) | 8067000 |

PASO 2. Seleccionar los soportes

| | |
|--|---|
|  | SOPORTE DE TECHO GIRATORIO GLYDEA™ REFERENCIA: 8080400 |
| | Para minimizar el paso de la luz (máx. 2mm). Acero cincado. |

| | |
|--|---|
|  | SOPORTE AJUSTABLE DE PARED GLYDEA™ REFERENCIA: 8082060 |
| | Utilizado con cualquier soporte de techo. Acero, color blanco |

| | |
|---|---|
|  | SOPORTE DE TECHO ONE TOUCH GLYDEA™ REFERENCIA: 8081060 |
| | Para una fácil instalación. Acero, color blanco |

| | |
|--|---|
|  | SOPORTE DOBLE AJUSTABLE DE PARED GLYDEA™ REFERENCIA: 8083060 |
| | Utilizado con cualquier soporte de techo. Acero, color blanco |

PASO 3. Seleccionar los controles

RADIO CONTROL RTS

Control individual con emisor y/o pulsador de pared
(Motor DCT + receptor RTS 433)

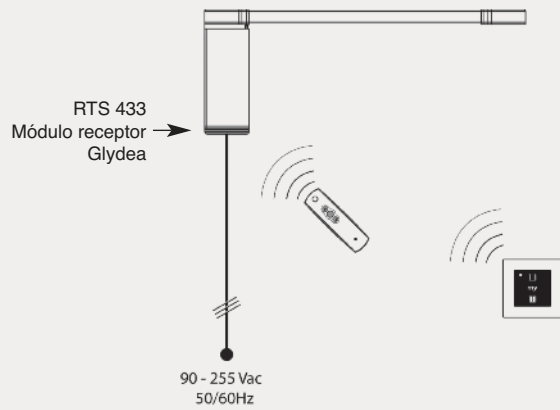

Control de grupo e individual con emisor de 4 canales
(Motores DCT + receptor RTS 433)

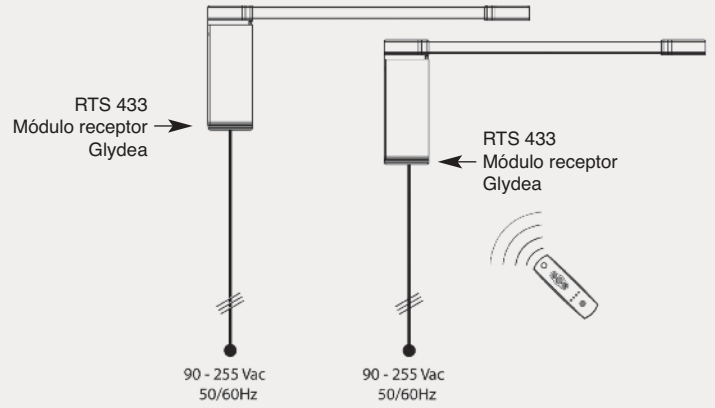

CONTROL POR CABLE

Control de grupo y/o individual DCT con pulsador control CA utilizando Módulo DCT Glydea™

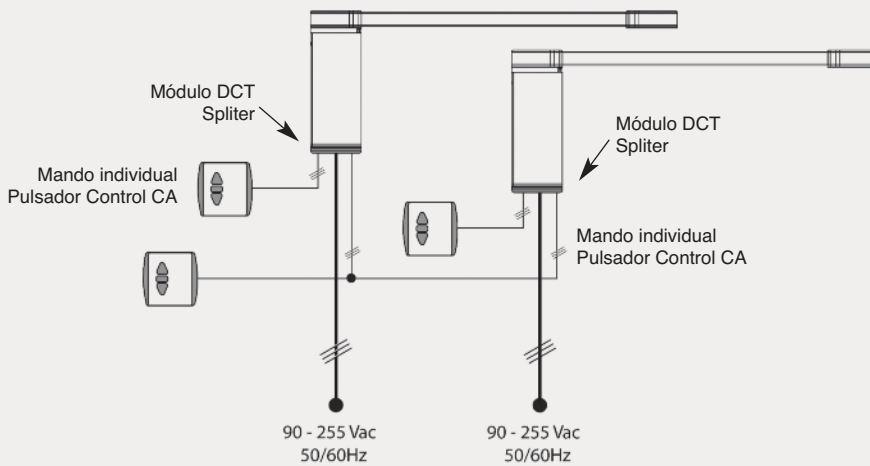

Mando individual con pulsador de CA

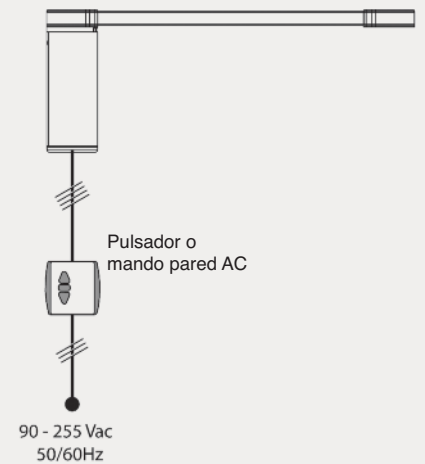

Mando individual o de grupo con pulsador de CA

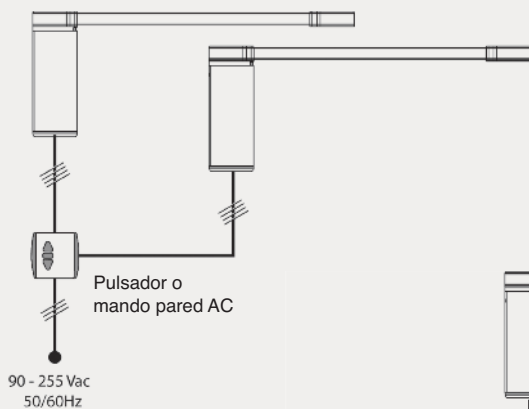

Control de grupo y/o individual WT con pulsador control CA

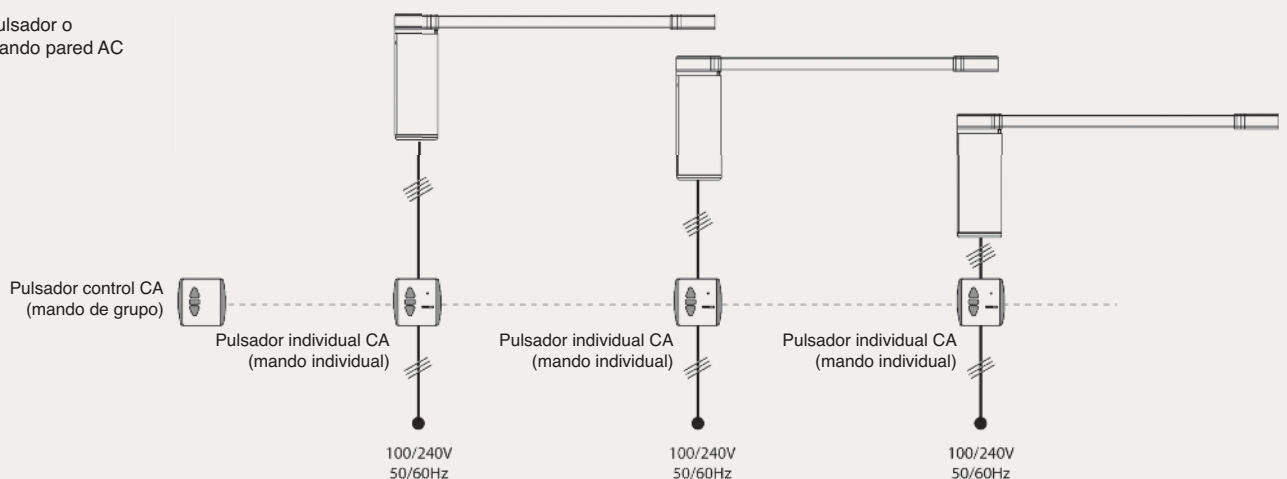

2. Elección de soportes para el montaje (se recomienda uno cada 50 cm.)

| | | |
|---|--|---|
|  | SOPORTE DE TECHO GIRATORIO GLYDEA™ | |
| | Soporte de techo para minimizar el paso de luz (máx. 2 mm) | |
| | Ref.: 8080400 | - |

| | | |
|--|---|---|
|  | SOPORTE DE TECHO ONE TOUCH GLYDEA™ | |
| | Para una fácil instalación | |
| | Ref.: 8081060 | - |

| | | |
|---|---|---|
|  | SOPORTE AJUSTABLE DE PARED GLYDEA™ | |
| | Utilizado con cualquier soporte de techo | |
| | Ref.: 8082060 | - |

| | | |
|--|---|---|
|  | SOP DOBLE AJUSTABLE DE PARED GLYDEA™ | |
| | Utilizado con cualquier soporte de techo | |
| | Ref.: 8083060 | - |

NOTA: Los soportes ajustables de pared requieren un soporte de techo (se acoplan a cualquiera de los dos soportes ajustables)

3. Motor y componentes necesarios para la motorización

| | | | |
|--|---|------------|--------|
|  | MOTOR PARA MONTAJE POR RADIO CONTROL | REFERENCIA | PRECIO |
| | MOTOR 35 DCT: Contacto seco, unidad de cable de 1,5 m de 3 hilos (Para cortinas con peso hasta 35 kg.) | 8064000 | - |
| | MOTOR 60 DCT: Contacto seco, unidad de cable de 1,5 m de 3 hilos (Para cortinas con peso hasta 60 kg.) | 8066000 | - |

| | |
|--|---------------|
| MÓDULO RECEPTOR RTS 433 GLYDEA™ | |
|  | Ref.: 8068000 |
| | - |









| | | |
|---|--|---|
|  | MÓDULO RTS DE PARED TÁCTIL DE 1 CANAL | |
| | Módulo RTS de pared táctil de un canal (los marcos deben pedirse por separado) ★ | |
| | Ref.: 8092000 | - |

También disponible en negro

| | | |
|---|-------------------------------------|---|
|  | MANDO A DISTANCIA DE 1 CANAL | |
| | Mando a distancia RTS de un canal | |
| | Ref.: 8093000 | - |

| | | |
|---|---------------------------------------|---|
|  | MANDO A DISTANCIA DE 4 CANALES | |
| | Mando a distancia RTS de 4 canales | |
| | Ref.: 8094000 | - |

★ Los módulos RTS de pared tiene marcos en distintos colores que se sirven aparte:

| | | | | | | | |
|---|---|---|---|---|---|---|---|
|  |  |  |  |  |  |  |  |
| Natural | Nogal | Teca | Roble | Negro | Cerezo | Plata | Plata mate |
| Ref.: 8012000 | Ref.: 8012010 | Ref.: 8012030 | Ref.: 8012040 | Ref.: 8012070 | Ref.: 8012110 | Ref.: 8012400 | Ref.: 8012420 |
| - | - | - | - | - | - | - | - |

| | | | |
|---|--|------------|--------|
|  | MOTOR PARA MONTAJE CONTROL POR CABLE | REFERENCIA | PRECIO |
| | MOTOR 35 WT: Control de conmutación CA, unidad de cable de 1,5 m de 4 hilos (Para cortinas con peso hasta 35 kg.) | 8065000 | - |
| | MOTOR 60 WT: Control de conmutación CA, unidad de cable de 1,5 m de 4 hilos (Para cortinas con peso hasta 60 kg.) | 8067000 | - |

| | | |
|---|---|---|
|  | PULSADOR FIJO INDIVIDUAL | |
| | Interruptor mantenido mediante control individual | |
| | Ref.: 8090000 | - |

| | | |
|---|---|---|
|  | PULSADOR FIJO INDIVIDUAL CA | |
| | Control de CA individual con conexión de bus de control principal | |
| | Ref.: 8095000 | - |

| | | |
|---|--|---|
|  | PULSADOR FIJO INDIVIDUAL CONTROL CA | |
| | Interruptor de contacto seco para control principal de bus | |
| | Ref.: 8096000 | - |

| | | |
|---|---|---|
|  | TEMPORIZADOR GLYDEA™ | |
| | Temporizador para control de línea de bus principal | |
| | Ref.: 8042000 | - |

LOS PRECIOS DE LOS PRODUCTOS SOMFY SON NETOS

GAMA DE MOTORIZACIÓN DE CORTINAS "CHYC"



RIEL CHYC, incluye en su catálogo 2015, esta nueva línea de rieles motorizados de la marca **CHYC**.





RIEL MOTORIZADO "CHYC" CON MANDO A DISTANCIA

NOVEDAD

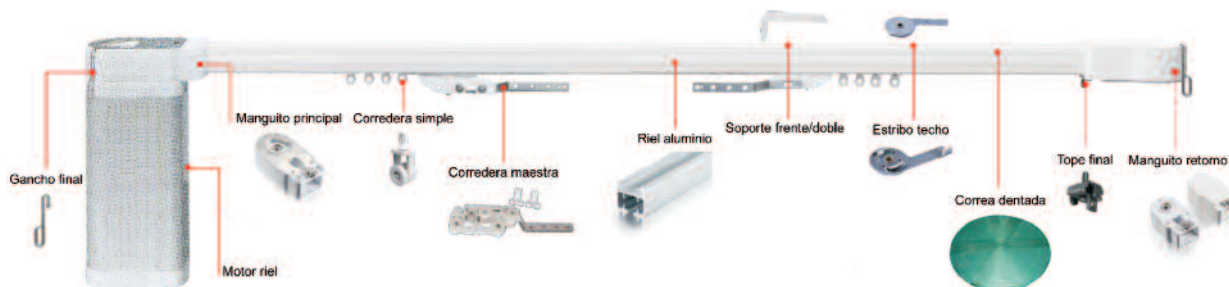

| REFERENCIA | <----> | NÚMERO DE SOPORTES | P.V.P. SOPORTE TECHO | | P.V.P. SOPORTE PARED | |
|------------|--------------------------------------|--------------------|----------------------|---------------|----------------------|---------------|
| | | | APER. LATERAL | APER. CENTRAL | APER. LATERAL | APER. CENTRAL |
| 8200100 | Riel motorizado "CHYC" hasta 100 cm. | 2 | - | - | - | - |
| 8200120 | Riel motorizado "CHYC" 100-120 cm. | 2 | - | - | - | - |
| 8200140 | Riel motorizado "CHYC" 121-140 cm. | 3 | - | - | - | - |
| 8200160 | Riel motorizado "CHYC" 141-160 cm. | 3 | - | - | - | - |
| 8200180 | Riel motorizado "CHYC" 161-180 cm. | 3 | - | - | - | - |
| 8200200 | Riel motorizado "CHYC" 181-200 cm. | 4 | - | - | - | - |
| 8200220 | Riel motorizado "CHYC" 201-220 cm. | 4 | - | - | - | - |
| 8200240 | Riel motorizado "CHYC" 221-240 cm. | 4 | - | - | - | - |
| 8200260 | Riel motorizado "CHYC" 241-260 cm. | 5 | - | - | - | - |
| 8200280 | Riel motorizado "CHYC" 261-280 cm. | 5 | - | - | - | - |
| 8200300 | Riel motorizado "CHYC" 281-300 cm. | 5 | - | - | - | - |
| 8200320 | Riel motorizado "CHYC" 301-320 cm. | 6 | - | - | - | - |
| 8200340 | Riel motorizado "CHYC" 321-340 cm. | 6 | - | - | - | - |
| 8200360 | Riel motorizado "CHYC" 341-360 cm. | 6 | - | - | - | - |
| 8200380 | Riel motorizado "CHYC" 361-380 cm. | 7 | - | - | - | - |
| 8200400 | Riel motorizado "CHYC" 381-400 cm. | 7 | - | - | - | - |
| 8200420 | Riel motorizado "CHYC" 401-420 cm. | 7 | - | - | - | - |
| 8200440 | Riel motorizado "CHYC" 421-440 cm. | 8 | - | - | - | - |
| 8200460 | Riel motorizado "CHYC" 441-460 cm. | 8 | - | - | - | - |
| 8200480 | Riel motorizado "CHYC" 461-480 cm. | 8 | - | - | - | - |
| 8200500 | Riel motorizado "CHYC" 481-500 cm. | 9 | - | - | - | - |
| 8200520 | Riel motorizado "CHYC" 501-520 cm. | 9 | - | - | - | - |
| 8200540 | Riel motorizado "CHYC" 521-540 cm. | 9 | - | - | - | - |
| 8200560 | Riel motorizado "CHYC" 541-560 cm. | 10 | - | - | - | - |
| 8200580 | Riel motorizado "CHYC" 561-580 cm. | 10 | - | - | - | - |
| 8200600 | Riel motorizado "CHYC" 581-600 cm. | 10 | - | - | - | - |
| 8200620 | Riel motorizado "CHYC" 601-620 cm. | 11 | - | - | - | - |
| 8200640 | Riel motorizado "CHYC" 621-640 cm. | 11 | - | - | - | - |
| 8200660 | Riel motorizado "CHYC" 641-660 cm. | 11 | - | - | - | - |
| 8200680 | Riel motorizado "CHYC" 661-680 cm. | 12 | - | - | - | - |
| 8200700 | Riel motorizado "CHYC" 681-700 cm. | 12 | - | - | - | - |
| 8200720 | Riel motorizado "CHYC" 701-720 cm. | 12 | - | - | - | - |
| 8200740 | Riel motorizado "CHYC" 721-740 cm. | 13 | - | - | - | - |
| 8200760 | Riel motorizado "CHYC" 741-760 cm. | 13 | - | - | - | - |
| 8200780 | Riel motorizado "CHYC" 761-780 cm. | 13 | - | - | - | - |
| 8200800 | Riel motorizado "CHYC" 781-800 cm. | 14 | - | - | - | - |
| 8200820 | Riel motorizado "CHYC" 801-820 cm. | 14 | - | - | - | - |
| 8200840 | Riel motorizado "CHYC" 821-840 cm. | 14 | - | - | - | - |
| 8200860 | Riel motorizado "CHYC" 841-860 cm. | 15 | - | - | - | - |
| 8200880 | Riel motorizado "CHYC" 861-880 cm. | 15 | - | - | - | - |
| 8200900 | Riel motorizado "CHYC" 881-900 cm. | 15 | - | - | - | - |
| 8200920 | Riel motorizado "CHYC" 901-920 cm. | 16 | - | - | - | - |
| 8200940 | Riel motorizado "CHYC" 921-940 cm. | 16 | - | - | - | - |
| 8200960 | Riel motorizado "CHYC" 941-960 cm. | 16 | - | - | - | - |
| 8200980 | Riel motorizado "CHYC" 961-980 cm. | 17 | - | - | - | - |
| 8201000 | Riel motorizado "CHYC" 981-1000 cm. | 17 | - | - | - | - |
| 8201020 | Riel motorizado "CHYC" 1001-1020 cm. | 17 | - | - | - | - |
| 8201040 | Riel motorizado "CHYC" 1021-1040 cm. | 18 | - | - | - | - |
| 8201060 | Riel motorizado "CHYC" 1041-1060 cm. | 18 | - | - | - | - |
| 8201080 | Riel motorizado "CHYC" 1061-1080 cm. | 18 | - | - | - | - |
| 8201100 | Riel motorizado "CHYC" 1081-1100 cm. | 19 | - | - | - | - |
| 8201120 | Riel motorizado "CHYC" 1101-1120 cm. | 19 | - | - | - | - |
| 8201140 | Riel motorizado "CHYC" 1121-1140 cm. | 19 | - | - | - | - |
| 8201160 | Riel motorizado "CHYC" 1141-1160 cm. | 20 | - | - | - | - |
| 8201180 | Riel motorizado "CHYC" 1161-1180 cm. | 20 | - | - | - | - |
| 8201200 | Riel motorizado "CHYC" 1181-1200 cm. | 20 | - | - | - | - |

1. Esta tarifa incorpora **P.V.P.** de riel motorizado con mando a distancia individual, fijación con soporte a techo o a pared y apertura lateral o central para cada tipo de fijación. Si desea incluir variables como soporte doble u otro tipo de mando, **CONSULTAR.**
2. El riel se programará y se probará en nuestras instalaciones y será remitido al cliente preparado para su colocación.
3. El plazo de entrega es de 5 días hábiles desde la confirmación del pedido.



ACCESORIOS OPCIONALES

NOVEDAD

MOTOR RIEL MCHC



EMISOR 1 CANAL MCHC



EMISOR 2 CANALES MCHC



| | | | |
|------|----------------|----------------|----------------|
| REF. | 8201000 | 8202000 | 8203000 |
| | x 1 | x 1 | x 1 |
| | - | - | - |

EMPALME PERFIL MCHC

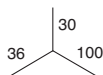

CORREDERA SIMPLE RIEL MCHC

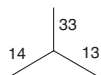

SOPORTE FRENTE RIEL MCHC

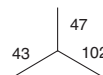
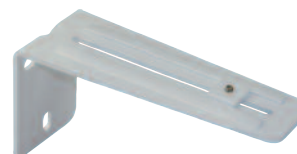

| | | | |
|------|----------------|----------------|----------------|
| REF. | 8207060 | 8208060 | 8209060 |
| | x 200 | x 2500 | x 200 |
| | - | - | - |

SOPORTE DOBLE RIEL MCHC

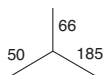
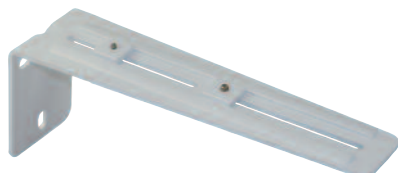

ESTRIBO TECHO RIEL MCHC

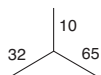

GANCHO FINAL RIEL MCHC

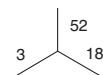

| | | | |
|------|----------------|----------------|----------------|
| REF. | 8210060 | 8211400 | 8215400 |
| | x 200 | x 100 | x 500 |
| | - | - | - |

** Colores: **06**= Blanco. **40**= Plata.
Código de envasado: **0**= Granel.

ALUMINIO

INSTRUCCIONES RIEL MOTORIZADO CHYC-AM95



MODOS DE CONTROL DEL MOTOR (UNA O DOS CORREDERAS)

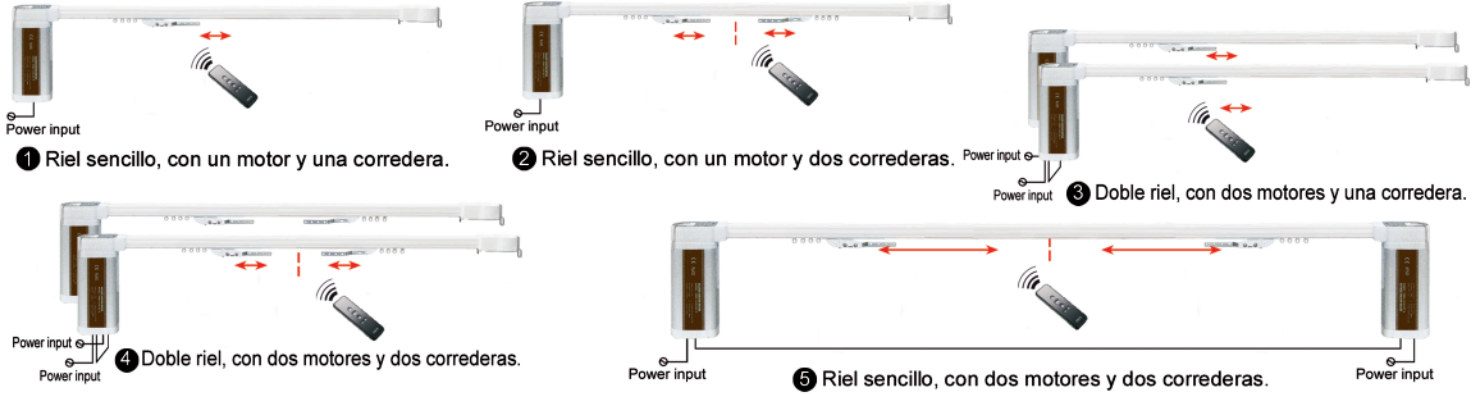

CARACTERÍSTICAS DEL MOTOR

- Diseño super silencioso:** Arranque y parada muy silenciosos. Movimiento elegante de la cortina.
- Parada por bloqueo:** La cortina se para automáticamente cuando la corredera nota resistencia al avance.
- Múltiples conexiones:** El interface standard soporta la conexión de varios motores que pueden ser accionados por interruptores externos o un sólo control central.
- Función "Light touch":** Al mover la cortina 5 cm., el motor se pone en marcha de forma automática.
- Varios modos de control:** Radiofrecuencia, cable, RS232/485, etc...
- Velocidad ajustable:** Posibilidad de ajustar tres velocidades diferentes.
- Operación manual:** Posibilidad de abrir y cerrar la cortina con el motor parado.
- Límites de recorrido autoajustables:** Memoriza las posiciones de final de recorrido de la cortina, para proteger los componentes y evitar daños en los mismos.

CARACTERÍSTICAS DEL RIEL

- Nivel de ruido menor de 30 dB en el motor principal.
- Uso de rodamientos de bolas para asegurar un movimiento equilibrado y silencioso.
- Estribos a techo con estructura oculta en acero inoxidable AISI304.
- Antena oculta de gran sensibilidad.
- Manguitos con doble rodamiento de bolas para asegurar un sistema equilibrado y silencioso.
- El motor puede ser instalado indistintamente por debajo o por encima del manguito.

PARÁMETROS:

| MODELO N° | PAR MOTOR | VELOCIDAD | TAMAÑO MOTOR | VOLTAJE | POTENCIA | PROTECCIÓN |
|-----------------|-----------|-----------|----------------|-----------------------|----------|------------|
| AM95-1/100-ML-P | 1N.m | 16cm/s | 215,5x94x56mm. | AC100-240V 50/60Hz | 96W | IP20 |

ESQUEMA DE CARGA

| UN SOLO MOTOR | | 1N.m | | |
|-------------------|-------------------------------------|--------|----------------------------------|--------|
| MOTOR Y CORREDERA | PESO DE LA TELA / LONGITUD DEL RIEL | 4 m. | 8 m. | 12 m. |
| | | | Un solo motor con dos correderas | 60 Kg. |
| | Un solo motor con una corredera | 50 Kg. | 45 Kg. | 40 Kg. |
| | Un solo motor con dos correderas | 45 Kg. | 40 Kg. | 35 Kg. |
| | Un solo motor con una corredera | 40 Kg. | 35 Kg. | 30 Kg. |
| | Un solo motor con dos correderas | 35 Kg. | 30 Kg. | 25 Kg. |
| | Un solo motor con una corredera | 30 Kg. | 25 Kg. | 20 Kg. |
| | Un solo motor con dos correderas | 31 Kg. | 21 Kg. | |
| | Un solo motor con una corredera | 21 Kg. | 16 Kg. | |

| DOS MOTORES | | 1N.m |
|-------------------|-------------------------------------|--------|
| MOTOR Y CORREDERA | PESO DE LA TELA / LONGITUD DEL RIEL | 12 m. |
| | | |
| | Dos motores con una corredera | 70 Kg. |
| | Dos motores con dos correderas | 60 Kg. |
| | Dos motores con una corredera | 50 Kg. |
| | Dos motores con dos correderas | 40 Kg. |
| | Dos motores con una corredera | 30 Kg. |
| | Dos motores con dos correderas | 30 Kg. |
| | Dos motores con una corredera | 23 Kg. |

Peso de la tela = peso por m² (Kg/m²) x tamaño (m²) x rapport.

Observación: La carga máxima de peso en los esquemas no incluye la fricción entre la tela y el riel de la cortina.

INSTRUCCIONES RIEL MOTORIZADO CHYC-AM95



INSTALACIÓN DEL MOTOR

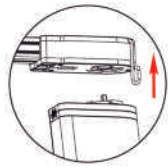

Insertar el motor en el manguito principal

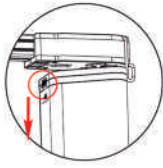

Mantener pulsado el botón de bloqueo, girar el motor y soltar el botón.

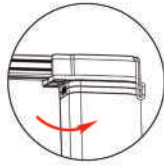

Instalación terminada.

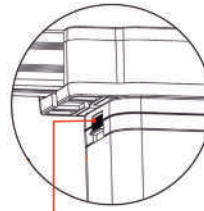

BOTÓN DE BLOQUEO

DESINSTALACIÓN DEL MOTOR

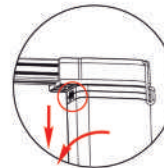

Mantener pulsado el botón de bloqueo, girar el motor para desconectarlo del manguito principal y soltar el botón. Sacar el motor.

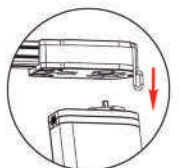

Precaución: Por favor, seguir los pasos de instalación. El techo debe de ser lo suficientemente fuerte para soportar el peso del riel, el motor y la tela.

INSTALACIÓN DEL SOPORTE FRENTE

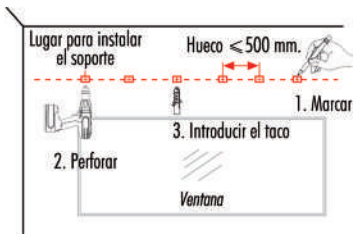

1. Marcar y hacer los agujeros

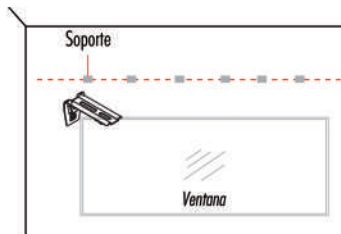

2. Instalar el soporte frente

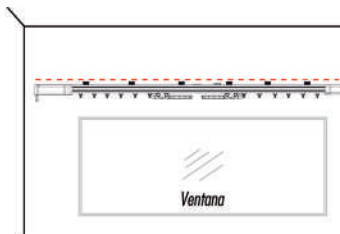

3. Instalar el riel

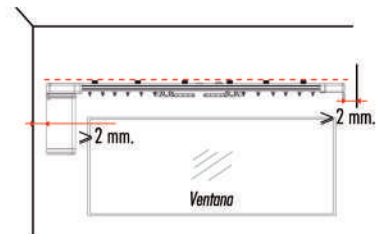

4. Instalar el motor

INSTALACIÓN DEL SOPORTE TECHO

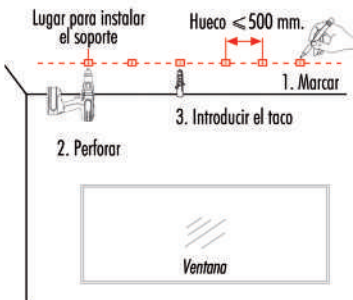

1. Marcar y hacer los agujeros

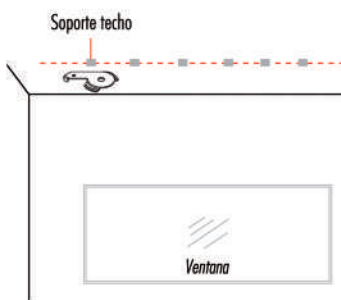

2. Instalar el soporte techo

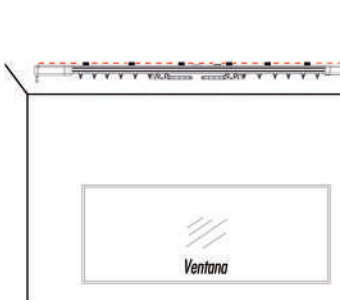

3. Instalar el riel

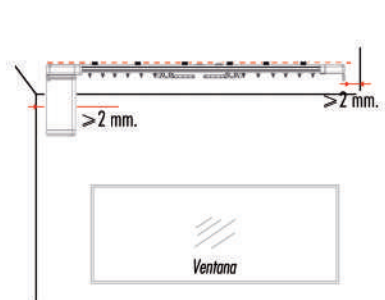

4. Instalar el motor

INSTALACIÓN CON MOLDURAS

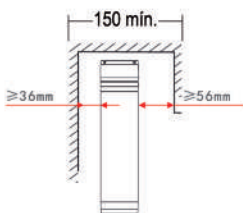

Instalación de un riel

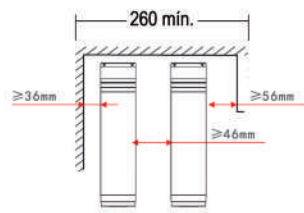

Instalación de dos rieles (2 cortinas)

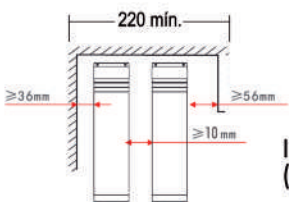

Instalación de dos rieles (Cortinas + visillo)

CABLEADO

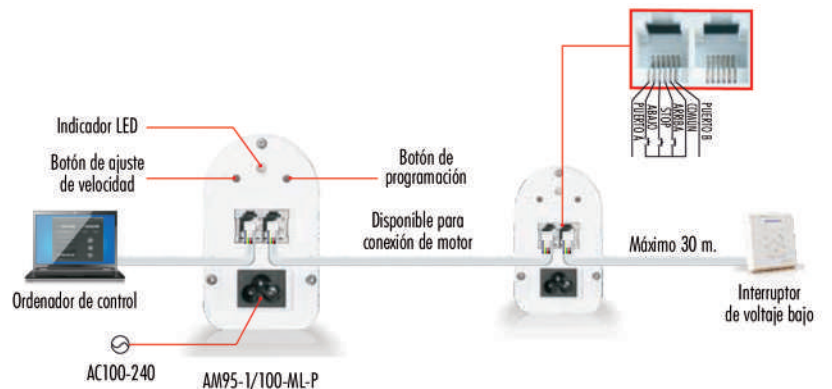

Precaución:

- El interruptor externo manual es de contacto seco.
- Los puertos serie A y B tienen la misma función.